



Limit switches



Limit switches XCW

The limit switches XCWD, designed for intensive use, have:

- 2 or 4 electrically separate snap action contacts
- heads that can be adjusted from 15° to 15° on 360° relative to the body
- a wide choice of actuators, 4 cable lengths
- distance of fixing holes identical to the previous range XCWA, they can easily substitute

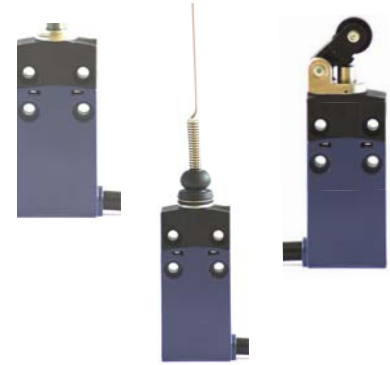





Specifications

Material	Zamak	Shock resistance	25 gn (18ms) according to IEC 60068-2-27
IP rating	IP66 - IP67	Vibration resistance	5 gn selon IEC 60068-2-27
Operating temperature	-20°C to +60°C	Rated thermal current	6 A for 2 according versions, 3 A for 4 contacts
Storage temperature	-40°C to +70°C	Rated insulation voltage	400 V according to IEC 60947-5-1
Approvals	INERIS 03ATEX0083X	Contacts, snap action	1 x NC + 1 x NO or 2 x NC + 2 x NO
Standards	EN/IEC: 60079-0, 60079-1, 60079-31	Resistance across terminals	≤ 25 mΩ according to IEC 60255-7 category 3
Ex-code	II 2 GD Ex d IIC T6 Gb Ex tb IIIC T85°C Db	Operational characteristics	Switches with 2 contacts AC-15 ; C300 (Ue = 240 V, Ie = 1.5 A) DC-13 ; R300 (Ue = 250 V, Ie = 0.1 A) Switches with 4 contacts AC-15 ; C300 (Ue = 240 V, Ie = 0.75 A) DC-13 ; R300 (Ue = 250 V, Ie = 0.1 A)
Repeat accuracy	0.05 mm on the tripping points, with 1 million operation cycles for actuator with end plunger		

Limit switch Ex d with actuators mounted. Heavy duty and compact with 2 or 4 snap action contacts

Part number by type of actuator with cable	Fixing by the body				Fixing by the head			
								
	2 contacts	4 contacts	2 contacts	4 contacts	2 contacts	4 contacts	2 contacts	4 contacts
1 m long	XCWD2110L1	XCWD4110L1	XCWD2102L1	XCWD4102L1	XCWD21F0L1	XCWD410L1	XCWD21F2L1	XCWD41F2L1
2 m long	XCWD2110L2	XCWD4110L2	XCWD2102L2	XCWD4102L2	XCWD21F0L2	XCWD410L2	XCWD21F2L2	XCWD41F2L2
5 m long	XCWD2110L5	XCWD4110L5	XCWD2102L5	XCWD4102L5	XCWD21F0L5	XCWD410L5	XCWD21F2L5	XCWD41F2L5
10 m long	XCWD2110L10	XCWD4110L10	XCWD2102L10	XCWD4102L10	XCWD21F0L10	XCWD410L10	XCWD21F2L10	XCWD41F2L10

Part number by type of actuator with cable	Fixing by the body							
								
	2 contacts	4 contacts	2 contacts	4 contacts	2 contacts	4 contacts	2 contacts	4 contacts
1 m long	XCWD2115L1	XCWD4115L1	XCWD2116L1	XCWD4116L1	XCWD2145L1	XCWD4145L1	XCWD2146L1	XCWD4146L1
2 m long	XCWD2115L2	XCWD4115L2	XCWD2116L2	XCWD4116L2	XCWD2145L2	XCWD4145L2	XCWD2146L2	XCWD4146L2
5 m long	XCWD2115L5	XCWD4115L5	XCWD2116L5	XCWD4116L5	XCWD2145L5	XCWD4145L5	XCWD2146L5	XCWD4146L5
10 m long	XCWD2115L10	XCWD4115L10	XCWD2116L10	XCWD4116L10	XCWD2145L10	XCWD4145L10	XCWD2146L10	XCWD4146L10

FOR WIDER CHOICE OF ACTUATORS REFER TO THE NEXT PAGES

Dimensions (mm) and characteristics

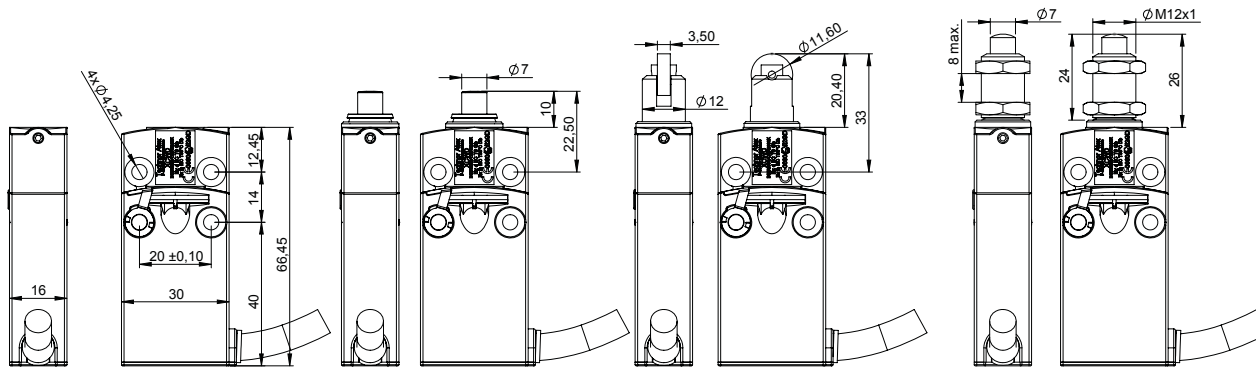

Switch actuation	On end	By 30° cam	On end
Maximum actuation speed	0.5 m/s	0.5 m/s	0.5 m/s
Mechanical durability	10 million operating cycles		
Minimum force or torque	for tripping	8.5 N	7 N
	for positive opening	42.5 N	35 N
Cabling	PvR cable: 5 x 0.75 mm ² for 2-pole contact versions, 9 x 0.34 mm ² for 4-pole contact versions		

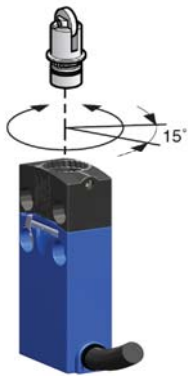

All actuators can be adjusted from 15° to 15° on 360° relative to the body

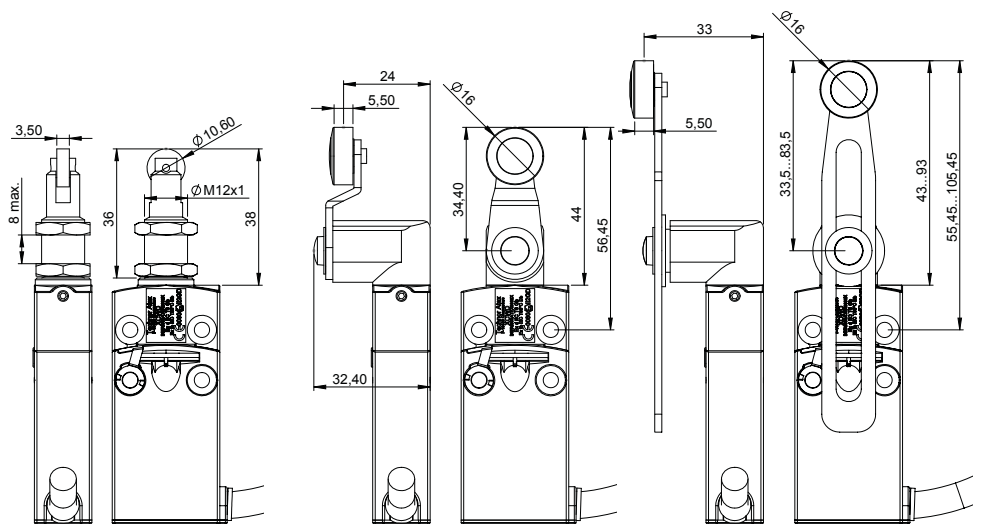

Switch actuation	By 30° cam	By 30° cam	By 30° cam
Maximum actuation speed	0.1 m/s	1.5 m/s	
Mechanical durability	10 million operating cycles		
Minimum force or torque	for tripping	7 N	0.1 N.m
	for positive opening	35 N	0.5 N.m
Cabling	PvR cable: 5 x 0.75 mm ² for 2-pole contact versions, 9 x 0.34 mm ² for 4-pole contact versions		

Contacts blocks

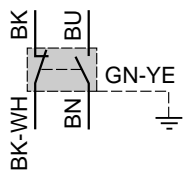

Switches with 2-pole contacts
 NC + NO
 snap action

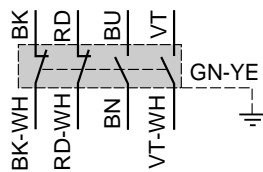

Switches with 4-pole contacts
 NC + NC + NO + NO
 snap action

Variable components - Actuator and body unassembled

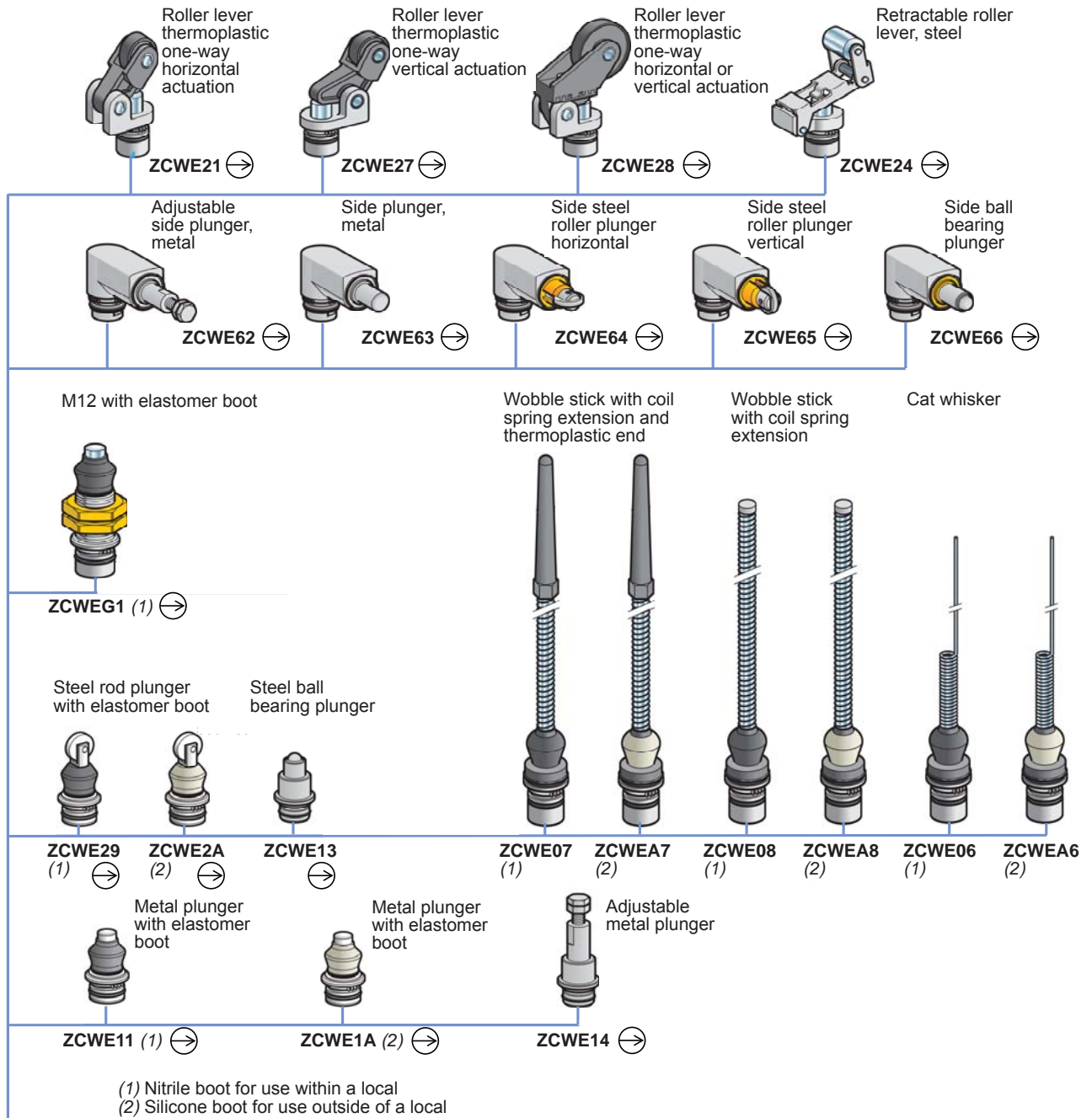

Part number of the body - When ordering specify the selected actuator

Number of contacts (3)	Body with cable 1 m long	Body with cable 2 m long	Body with cable 5 m long	Body with cable 10 m long
2 contacts: 1xNO + 1xNC	ZCWD21L1	ZCWD21L2	ZCWD21L5	ZCWD21L10
4 contacts: 2xNO + 2xNC	ZCWD41L1	ZCWD41L2	ZCWD41L5	ZCWD41L10

(3) Snap action contacts



Variable components - Actuator, head and body unassembled

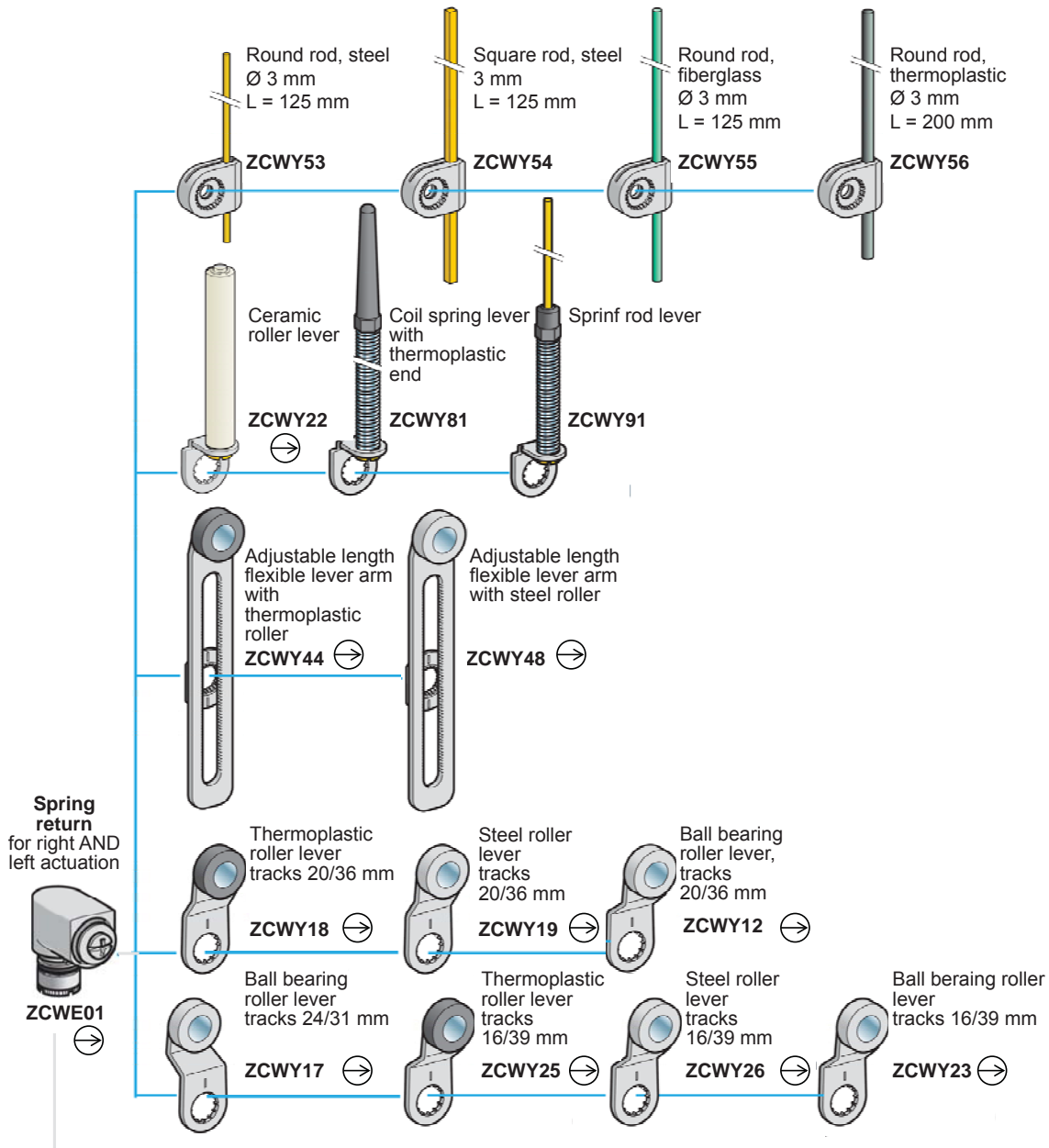

Part number of the body - When ordering specify the part ZCWE01 and the selected actuator

Number of contacts (3)	Body with cable 1 m long	Body with cable 2 m long	Body with cable 5 m long	Body with cable 10 m long
2 contacts: 1xNC + 1xNO	ZCWD21L1	ZCWD21L2	ZCWD21L5	ZCWD21L10
4 contacts: 2xNC + 2xNO	ZCWD41L1	ZCWD41L2	ZCWD41L5	ZCWD41L10

(3) Snap action contacts



The XCK and XCR ranges of limit switches are based on Télémecanique series of operator heads and bodies and is equipped with Ex ed Ex-tech Solution contact block suitable for Zone 1 use. The products are well known around the world for their reliability, design and flexibility of application. The XCKW series are supplied with fitted cable gland for easy installation.



Specifications

Material (body)	Zinc alloy (ZP3 - Zamak)
IP rating	IP65
Operating temperature	-20°C to +60°C
Approvals	INERIS03ATEX0039X, INERIS03ATEX0038X IECEX INE 12.0030X, IECEX INE 12.0029X
Standards	EN/IEC: 60079-0, 60079-1, 60079-7, 60079-18, 60079-31
Ex codes	II 2 GD Ex d e IIC T6 Gb Ex tb IIIC T85°C Db
Contact block	NO + NC - 500 V, 3A

Gas and dust	For dust only	Contact block for the dust versions	
XCKWMR54D1H29	XCKWMR54D1H29EX	Two 2-pole NC + NC staggered, slow break	
XCKWMR54D2H29	XCKWMR54D2H29EX		
XCRAW111	XCRAW111EX	Two 2-pole NC + NO snap action contacts, both operate in each direction	
XCRAW121	XCRAW121EX		
XCRAW151	XCRAW151EX		
XCREW181	XCREW181EX		
XCRBW111	XCRBW111EX		
XCRBW121	XCRBW121EX	Two 2-pole NC + NO snap action contacts, 1 operates in each direction	
XCRBW151	XCRBW151EX		
XCRFW171	XCRFW171EX		
XCRTW115	XCRTW115EX	2 single pole OC, snap action contacts	
XCRTW215	XCRTW215EX		
XCKWD2110P16	XCKWD3910P16EX	NC + NC + NO, snap action contacts	
XCKWD2111P16	XCKWD3911P16EX		
XCKWD2102P16	XCKWD3902P16EX		
XCKWD2121P16	XCKWD3921P16EX		
XCKWD2127P16	XCKWD3927P16EX		
XCKWD2128P16	XCKWD3928P16EX		
XCKWD2118P16	XCKWD3918P16EX		
XCKWD2139P16	XCKWD3939P16EX		
XCKWD2145P16	XCKWD3945P16EX		
XCKWD2149P16	XCKWD3949P16EX		
XCKWD2106P16	XCKWD3906P16EX		
XCKWD21H0P16	XCKWD39H0P16EX		
XCKWD21H2P16	XCKWD39H2P16EX		
XCKWM2110H29	XCKWM3910H29EX		NC + NC + NO, snap action contacts
XCKWM2102H29	XCKWM3902H29EX		
XCKWM2121H29	XCKWM3921H29EX		
XCKWM2115H29	XCKWM3915H29EX		
XCKWM2106H29	XCKWM3906H29EX		
XCKWJ2161H29	XCKWJ3961H29EX	NC + NC + NO, snap action contacts	
XCKWJ2167H29	XCKWJ3967H29EX		
XCKWJ210513H29	XCKWJ390513H29EX		
XCKWJ210511H29	XCKWJ390511H29EX		
XCKWJ210541H29	XCKWJ390541H29EX		
XCKWJ210559H29	XCKWJ390559H29EX		

XCKWMR, for lifting equipments, conveyors, handling devices (fixing distance 61.5 mm)



Type of actuator	Metallic rods in cross	Metallic rods in cross, reversed head
Mechanical durability	2 million cycles	
Actuation speed	1.5 m/s	
Cable entry	3 entries ISO M20 (1)	
Two 2 pole NC+NC staggered, slow break	XCKWMR54D1H29	XCKWMR54D2H29

(1) 2 entries with blind plug, 1 entry with cable gland ISO M20 for cable Ø 8 to 13mm

XCRA/B/TW, for lifting equipments, conveyors (fixing distance 85 x 75 mm)

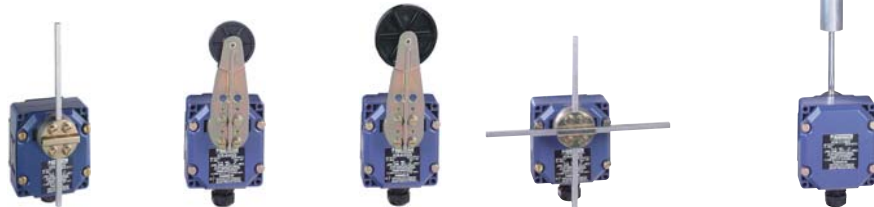

Type of actuator	Square rod 6mm spring return position	Thermoplastic roller lever Ø 30 mm	Thermoplastic roller lever Ø 50 mm	Metallic square rod in cross, stay put position	Conveyor belt shift monitoring Galvanized steel operating lever	Stainless steel operating lever
Mechanical durability	10 million cycles				0.3 million cycles	
Actuation speed	1.5 m/s					
Cable entry	1 entry ISO M20 for cable of Ø 8 to 13 mm					
Two 2-pole NC+NO snap action contacts, operate in each direction	XCRAW111	XCRAW121	XCRAW151	XCREW181 (2)		
1 contact "O + C" snap action in each direction	XCRBW111	XCRBW121	XCRBW151	XCRFW171 (3)		
2 contacts "O + C" snap action					XCRTW115	XCRTW215

(2) Metallic rods in cross

(3) Metallic rods in "T"

XCKWM, Classique range, fixing by the body (fixing distance 41 mm)



Type of actuator	Metal end plunger	Steel roller plunger	Thermoplastic roller lever, horizontal actuation	Thermoplastic roller lever	"Cat's whisker"
Mechanical durability	20 million cycles				10 million cycles
Actuation speed	0.5 m/s		1.5 m/s		0.5 m/s
Cable entry	3 entries ISO M20 (1)				
Snap action contact "O+C"	XCKWM2110H29	XCKWM2102H29	XCKWM2121H29	XCKWM2115H29	XCKWM2106H29

(1) 2 entries with blind plug, 1 entry with cable gland ISO M20 for cable Ø 8 to 13mm

XCKWD, Compact range, fixing by the body (fixing distance 20 mm)



Type of actuator	Metal end plunger	Booted metal end plunger	Steel roller plunger	Thermoplastic roller lever, horizontal actuation	Thermoplastic roller lever, vertical actuation	Thermoplastic roller lever, vertical or horizontal actuation
Mechanical durability	15 million cycles		10 million cycles	15 million cycles		
Actuation speed	0.5 m/s			1 m/s		
Cable entry	1 entry M16 for cable Ø 5 to 8 mm					
Snap action contact NO+NC	XCKWD2110P16	XCKWD2111P16	XCKWD2102P16	XCKWD2121P16	XCKWD2127P16	XCKWD2128P16
Snap action contact NO+NO	XCKWD2910P16	XCKWD2911P16	XCKWD2902P16	XCKWD2921P16	XCKWD2927P16	XCKWD2928P16

XCKWD, Compact range, fixing by the body (fixing distance 20mm)



Type of actuator	Thermoplastic roller lever	Thermoplastic roller lever Ø 50 mm	Variable length thermoplastic roller lever	Variable length thermoplastic roller lever Ø 50 mm	"Cat's whisker"	M18 head Metal end plunger	M18 steel roller end plunger
Mechanical durability	10 million cycles				5 million cycles	10 million cycles	
Actuation speed	1.5 m/s				1 m/s	0.5 m/s	
Cable entry	1 entry ISO M16 for cable Ø 5 to 8 mm						
Snap action contact NO+NC	XCKWD2118P16	XCKWD2139P16	XCKWD2145P16	XCKWD2149P16	XCKWD2106P16	XCKWD21H0P16	XCKWD21H2P16
Snap action contact NO+NO	XCKWD2918P16	XCKWD2939P16	XCKWD2945P16	XCKWD2949P16	XCKWD2906P16	XCKWD29H0P16	XCKWD29H2P16

XCKWJ, Compact range, fixing by the body (fixing distance 30 x 60 mm)



Type of actuator	Metal end plunger	Steel roller plunger	Steel roller lever	Thermoplastic roller lever	Variable length thermoplastic roller lever	Round rod lever Ø 6mm polyamide L= 200mm
Mechanical durability	30 million cycles	25 million cycles	30 million cycles		20 million cycles	
Actuation speed	0.5 m/s	1 m/s	1.5 m/s			
Cable entry	1 entry ISO M20 for cable Ø 8 to 13 mm					
Snap action contact O+C	XCKWJ2161H29	XCKWJ2167H29	XCKWJ210513H29	XCKWJ210511H29	XCKWJ210541H29	XCKWJ210559H29

Compact range, XCKWD (metal) - body + actuator

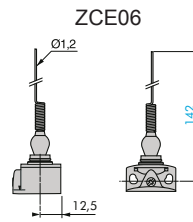
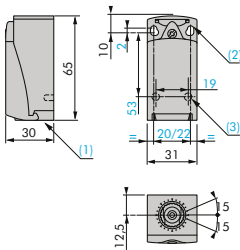

- 1) 1 entry ISO M16 x 1.5 for cable gland
- 2) 2 slotted holes $\varnothing 4.3 \times 6.3$ mm and fixing distance 22 mm or 2 holes $\varnothing 4.3$ mm and fixing distance 20 mm
- 3) 2 trous pour montage $\varnothing 3$ mm profondeur 4 mm

ZCE10

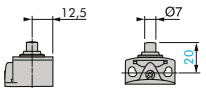

ZCE11

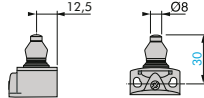

ZCE02

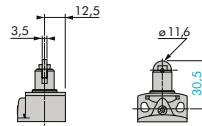

ZCE21

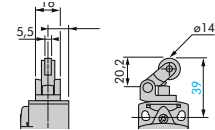

ZCE27

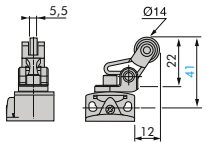

ZCE28

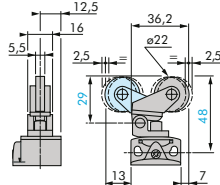

ZCEH0

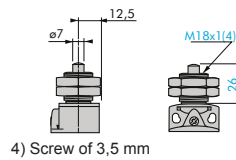

ZCEH2

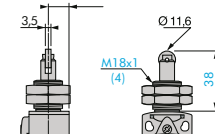

4) Screw of 3,5 mm

ZCE01 + ZCY18

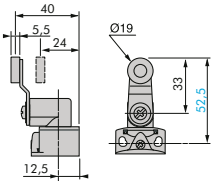

ZCE01 + ZCY45

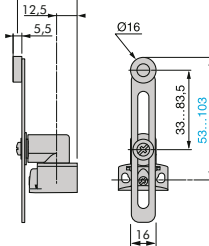

ZCEH01 + ZCY39

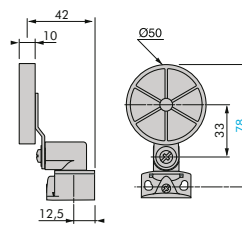

ZCE01 + ZCY49

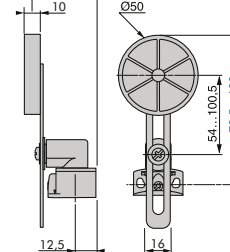

Classique range, XCKWJ (metal)

XCKWJ2161H29

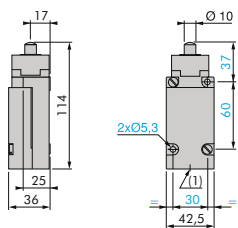

XCKWJ2167H29

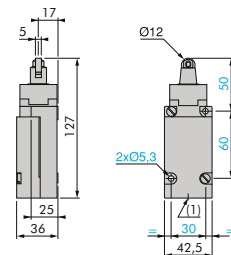

XCKWJ210513H29
XCKWJ210511H29

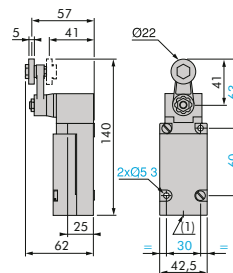

XCKWJ210541H2

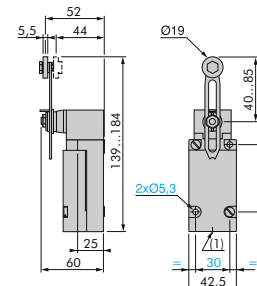

XCKWJ210559H29

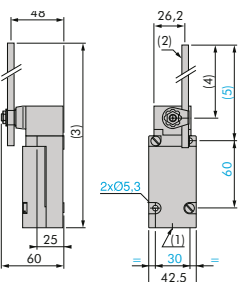

- 1) 1 entry ISO M20 x 1.5 for cable gland
- 2) Lever $\varnothing 6$ mm, length 120 mm
- 3) 2 slotted holes 5.3×7.3 mm

XCKWMR, XCRA/B/TW

XCKWMR54D1H29 / XCKWMR54D2H29

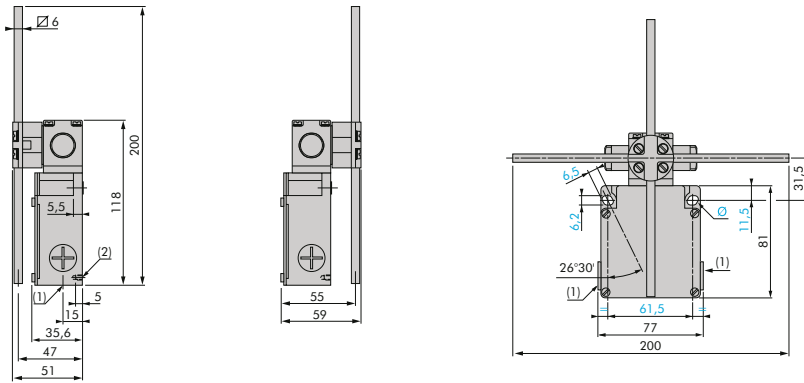

- 1) 3 entries ISO M20 x 1.5 for cable gland
- 2) 2 centring holes \varnothing 3.9 mm
- \varnothing) 2 slotted holes 6.2 x 6.5 mm

XCRAW111
XCRBW111

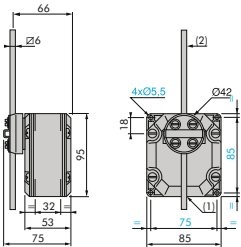

XCRAW121
XCRBW121

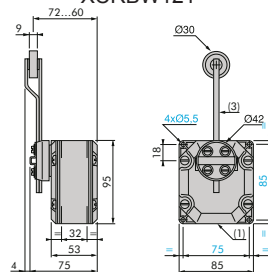

XCRAW151
XCRBW151

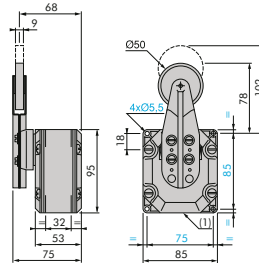

XCREW181
XCREW171

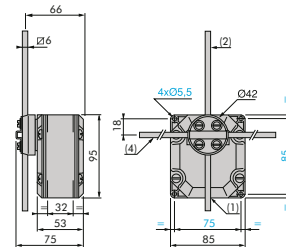

XCRTW115 / XCRTW215

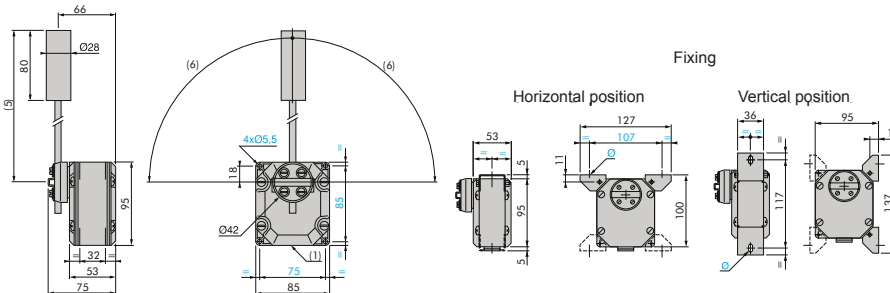

- 1) 1 entry ISO M20 x 1.5 for cable gland
- 2) Lever length : 200 mm
- 3) Lever length + roller : 160 mm
- 4) Lever length : 300 mm for XCRPW and 200 mm for XCREW
- 5) Max: 200 mm - Min: 83 mm
- 6) Max: 90°
- \varnothing) 2 slotted holes 6.2 x 6.5 mm

Classique range. XCKWM (metal)

XCKWM2110H29

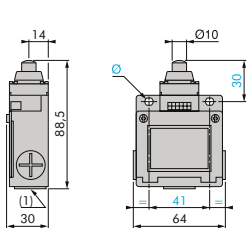

XCKWM2102H29

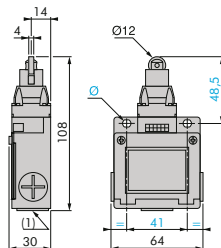

XCCKWM2121H29

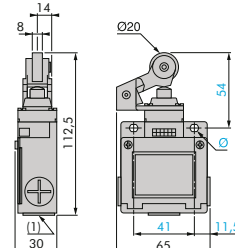

XCKWM2115H29

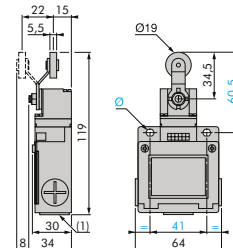

XCKWM2106H29

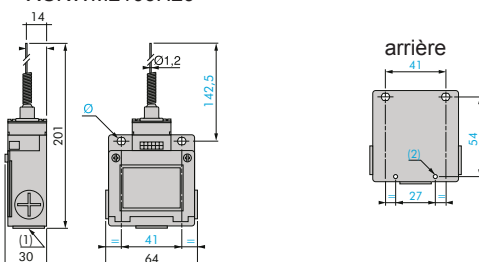

- 1) 3 entries ISO M20 x 1.5 for cable gland
- 2) 2 holes x \varnothing 4
- \varnothing) 2 slotted holes 5.2 x 6.2 mm

Photocells XUWB

With a footprint of only 30 mm in diameter, this prewired photo-electric sensor, ATEX certified Ex d, can be used in all types of applications. With a nominal range from 0.6 m to 15 m, it will be able to meet all needs.



Specifications

Material	Brass nickel plated or Stainless steel AISI 316L	Type of transmission	Infrared
IP rating	IP65 - IP67	Detection mode	In the housing axis
Operating temperature	-20°C to +55°C	Electrical connection	By cable 2 m for XUWB...L2 By cable 5 m for XUWB...L5
Approval	INERIS06ATEX0066X		
Standards	EN/IEC: 60079-0, 60079-1, 60079-31		
Ex codes	II 2 GD Ex d IIC T6 Gb IP66 T85°C Ex tb IIIC T85°C Db IP66		

Sensors for applications in DC circuit (static output)			
Type of detection	Reflex polarized	Reflex	Barrier
Rated operating distance (Sn) (m)	2	4	15
Diameter fixing	30 mm		
Supply voltage	12 to 24VDC with protection against reverse polarity		
Current consumption,	35 mA		
Maximum switching frequency	500 Hz		
Type of contact	PNP		
NO	XUWB9APANL2	XUWB1APANL2	XUWB2APANL2R
NC	XUWB9APBNL2	XUWB1APBNL2	XUWB2APBNL2R
Transmitter to add	-	-	XUWB2AKSNL2T
Type of contact	NPN		
NO	XUWB9ANANL2	XUWB1ANANL2	XUWB2ANANL2R
NC	XUWB9ANBNL2	XUWB1ANBNL2	XUWB2ANBNL2R
Transmitter to add	-	-	XUWB2AKSNL2T

For a length of 5m, replace L2 by L5. Example: XUWB5APANL2 becomes XUWB5APANL5

Accessories		
Reflectors		Reference
Standard reflectors	Ø 16	XUZC16
	Ø 21	XUZC21
	Ø 31	XUZC31
	Ø 39	XUZC39
Reflector for short sensing ranges	24 x 21	XUZC24

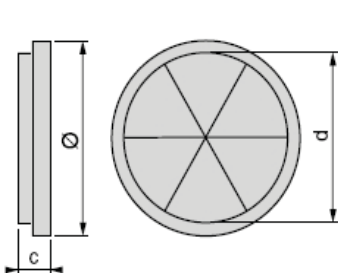

Standard reflector

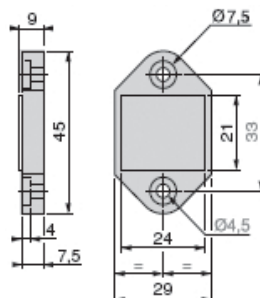

Reflector for short distance of detection



Limit switches XC8/ZC8

The XC8 and ZC8 ranges of limit switches is a combination of different bodies and actuators. Our standard product range boasts both robust construction and cable gland entry, making the XC8 and ZC8 a safe and easy choice for a wide variety of customer applications. In addition, further head types are available for those customers who need a more specialized product.



Specifications

Material	Cast iron (Painted)	Rated thermal current	6A
IP rating	IP66/67	Isolation voltage	500 V
Operating temperature	-20°C to +60°C (+80°C), -50°C to +60°C	Contact block	1 x O+C - 1 pole snap-action
Approval	INERIS 03ATEX0123	Resistance between terminals	≤ 25 mΩ
Standards	EN/IEC: 60079-0, 60079-1, 60079-31	Power use	Category: AC11, DC11
Ex code	II 2 GD Ex d IIC T6 Gb		
Mechanical durability	Ex tb IIIC T85°C Db		
	10 million of operation cycles		

Limit switches Ex d - "Severe duty" - 1 C+O snap action contact, with nickel plated cable gland ISO M20 - Available for armoured and non-armoured cable

Actuators with straight movement		Reference	Complete the reference	Weight (kg)
Steel plunger (1)		XC8JC161P1	• • •	2
Roller plunger (2)		XC8JC162P1	• • •	2
Side plunger (2)		XC8JC163P1	• • •	2
Heavy duty roller plunger (2)		XC8TA1P1	• • •	2,4
Heads with angular movement		Reference		
Thermoplastic roller lever (3)	Actuation from left and right	XC8JC10111P1	• • •	2,2
	Actuation from left or right (5)	XC8JC10511P1	• • •	2,2
Variable length (3)	Actuation from left and right	XC8JC10131P1	• • •	2,2
	Actuation from left or right (5)	XC8JC10531P1	• • •	2,2
Steel rod (4) 3 mm, length: 125 mm	Actuation from left and right	XC8JC10151P1	• • •	2,2
	Actuation from left or right (5)	XC8JC10551P1	• • •	2,2
Limit switch body only for plunger and rotary heads for plunger and rotary heads	1 contact "OC"	ZC8JC1P1	• • •	2,2
	2 x "OC", simultaneous	ZC8JC2P1	• • •	2,2
	1 contact "OC" + 1 contact "OC", 2 steps	ZC8JC4P1	• • •	2,2
	1 "OC" nitrogen filled contact	ZC8JCNP1	• • •	2,2
Cable entry				
Thread M20	1F for non armoured cable with clamping module		1 C	
	4F for armoured cable		4	
	Without cable gland		5	

- (1) Actuation on end. Maximum actuation speed: 0.5 m/s
 (2) Actuation by cam 30°. Maximum actuation speed: 0.5 m/s
 (3) Actuation by cam 30°. Maximum actuation speed: 1.5 m/s
 (4) Actuation by cylindrical finger. Maximum actuation speed: 1.5 m/s
 (5) By adjusting the operating head

Dimensions (mm)

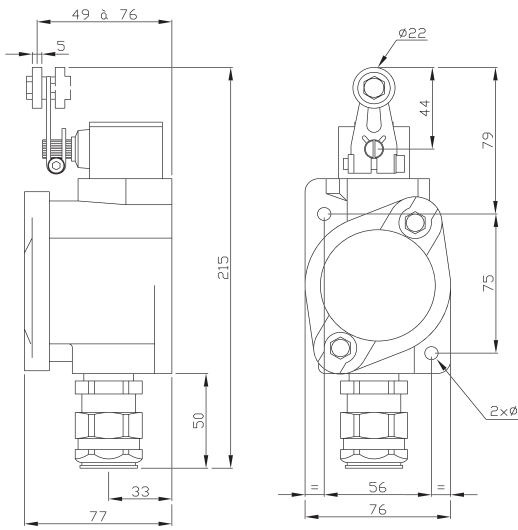

XC8-JC10111P1...
XC8-JC10511P1...

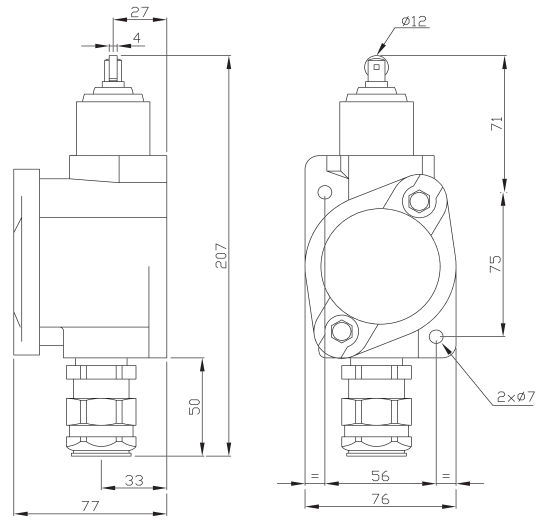

XC8-JC162P1...

Ranges XC8... / ZC8...

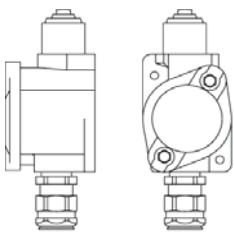

XC8-JC161P1

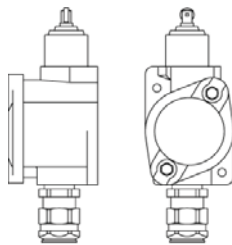

XC8-JC162P1

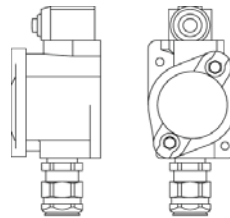

XC8-JC163P1

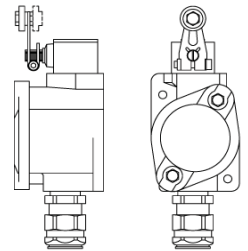

XC8JC10111P1
XC8JC10511P1

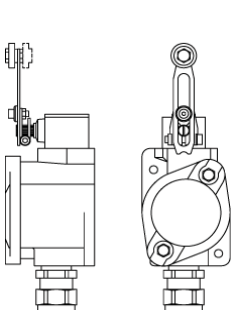

XC8JC10131P1
XC8JC10531P1

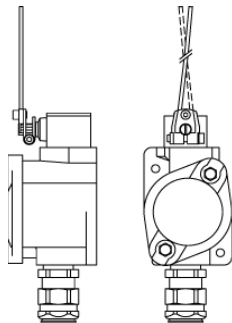

XC8JC10151P1
XC8JC10151P1

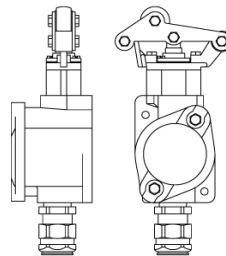

XC8TA1P1

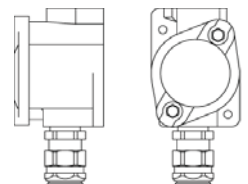

ZC8JC1P1 - ZC8JC2P1
ZC8JC4P1

The XML range of pressure switches is designed for applications where it is important to control fluids in your installation. With an extensive range for pressures and fluids, XMLWC gives you control in the hazardous area.



Specifications

Material	Zinc Alloy (ZP3 - Zamak)	Rated thermal current	6A
IP rating	IP66	Rated voltage	250 V
Operating temperature	-20°C to +60°C	Electrical connection	Screw terminal block, cable entry
Approval	INERIS04ATEX0007		ISO M20 for cable Ø 8 to 13 mm
Standards	EN/IEC: 60079-0, 60079-1, 60079-7	Short circuit protection	By fuse 10A gG (gl)
	60079-31	Hydraulic connection	1/4" gas female
Ex codes	For Tfluid < +65°C II 2 GD Ex d e IIC T6 Gb Ex tb IIIC T85°C Db		

Type	Vacuum switch with display		Pressure switch with display	
	- 1 bar		1 bar	1 bar
Gauge				
Setting range of upper threshold (PH)	-1 ... -0.14 bar		0.05 ... 1 bar	0.005 ... 1 bar
Fluids controlled	Hydraulic oils, water, air corrosive fluids		Oil, air	Water, corrosives fluids
Possible differential (add to PB to get PH)	Min. at low setting	0.13 bar	0.03 bar	0.03 bar
	Min. at high setting	0.14 bar	0.04 bar	0.04 bar
	Max. at high setting	0.8 bar	0.8 bar	0.8 bar
Single-pole snap action contact "O+C"	XMLW-CM02T2S12		XMLW-C001R2S12	XMLW-C001S2S12

Pressure switch with display - Gauge		4 bar	4 bar	10 bar
Setting range of upper threshold (PH)		0.3 ... 4 bar	0.3 ... 4 bar	0.7 ... 10 bar
Fluids controlled		Hydraulic oils, water, air	Corrosive fluids	Hydraulic oils, water, air
Possible differential (add to PB to get PH)	Min. at low setting	0.17 bar	0.17 bar	0.45 bar
	Min. at high setting	0.15 bar	0.15 bar	0.70 bar
	Max. at high setting	2.5 bar	2.5 bar	8 bar
Single-pole snap action contact "O+C"		XMLW-C004B2S12	XMLW-C004C2S12	XMLW-C010B2S12

Pressure switch with display - Gauge		10 bar	20 bar	20 bar
Setting range of upper threshold (PH)		0.7 ... 10 bar	1.3 ... 20 bar	1.3 ... 20 bar
Fluids controlled		Corrosive fluids	Oil, water, air	Corrosive fluids
Possible differential (add to PB to get PH)	Min. at low setting	0.45 bar	0.7 bar	0.7 bar
	Min. at high setting	0.70 bar	1 bar	1 bar
	Max. at high setting	8 bar	11 bar	11 bar
Single-pole snap action contact "O+C"		XMLW-C010C2S12	XMLW-C020B2S12	XMLW-C020C2S12

Pressure switch with display - Gauge			35 bar	35 bar
Setting range of upper threshold (PH)			3.5 ... 35 bar	3.5 ... 35 bar
Fluids controlled			Hydraulic oils, water, air	Corrosive fluids
Possible differential (add to PB to get PH)	Min. at low setting		1 bar	1 bar
	Min. at high setting		1.5 bar	1.5 bar
	Max. at high setting		22 bar	22 bar
Single-pole snap action contact "O+C"			XMLW-C035B2S12	XMLW-C035C2S12

Pressostat avec affichage - Calibre		70 bar	70 bar	70 bar
Setting range of upper threshold (PH)		7 ... 70 bar	7 ... 70 bar	7 ... 70 bar
Fluids controlled		Hydraulic oils, air	Fresh water, sea water	Corrosive fluids
Possible differential (add to PB to get PH)	Min. at low setting	4.5 bar	4.5 bar	4.5 bar
	Min. at high setting	8.9 bar	8.9 bar	8.9 bar
	Max. at high setting	60 bar	60 bar	60 bar
Single-pole snap action contact "O+C"		XMLW-C070D2S12	XMLW-C070E2S12	XMLW-C070N2S12

Pressure switch with display - Gauge		160 bar	160 bar	160 bar
Setting range of upper threshold (PH)		12 ... 160 bar	12 ... 160 bar	12 ... 160 bar
Fluids controlled		Hydraulic oils, air	Fresh water, sea water	Corrosive fluids
Possible differential (add to PB to get PH)	Min. at low setting	9 bar	9 bar	9 bar
	Min. at high setting	21 bar	21 bar	21 bar
	Max. at high setting	110 bar	110 bar	110 bar
Single-pole snap action contact "O+C"		XMLW-C160D2S12	XMLW-C160E2S12	XMLW-C160N2S12

Pressure switch with display - Gauge		300 bar	300 bar	300 bar
Setting range of upper threshold (PH)		22 ... 300 bar	22 ... 300 bar	22 ... 300 bar
Fluids controlled		Hydraulic oils, air	Fresh water, sea water	Corrosive fluids
Possible differential (add to PB to get PH)	Min. at low setting	16 bar	16 bar	16 bar
	Min. at high setting	35 bar	35 bar	35 bar
	Max. at high setting	240 bar	240 bar	240 bar
Single-pole snap action contact "O+C"		XMLW-C300D2S12	XMLW-C300E2S12	XMLW-C300N2S12

Pressure switch with display - Gauge		500 bar	500 bar	500 bar
Setting range of upper threshold (PH)		30 ... 500 bar	30 ... 500 bar	30 ... 500 bar
Fluids controlled		Hydraulic oils, air	Fresh water, sea water	Corrosive fluids
Possible differential (add to PB to get PH)	Min. at low setting	19 bar	19 bar	19 bar
	Min. at high setting	52 bar	52 bar	52 bar
	Max. at high setting	340 bar	340 bar	340 bar
Single-pole snap action contact "O+C"		XMLW-C500D2S12	XMLW-C500E2S12	XMLW-C500N2S12

Dimensions (mm)

XMLW-C010/020/035/070/160/300/500

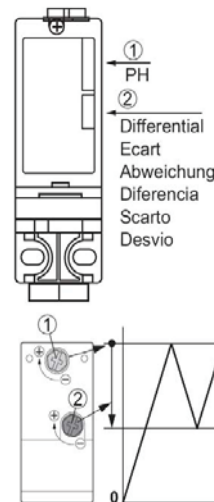
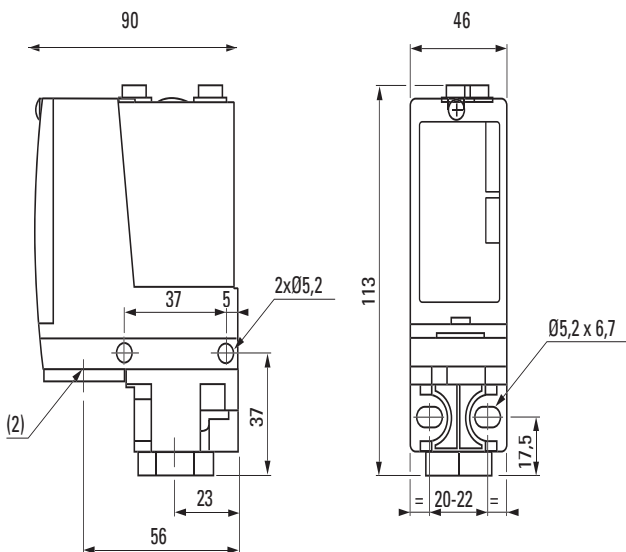

PH: Setting of upper threshold

PB: Setting of low threshold

Set the high threshold using the red screw "1" and the lower threshold (adjustable differential) using the green screw "2"

Hazardous area - Information & Terminology

The ATEX Directive, derived from the French “ATmosphères EXplosibles” and formally known as 94/9/EC, contains the ESR (Essential Safety Requirements) to which electrical equipment and protective systems used within potentially explosive atmospheres must conform.

The new ATEX Directive currently in place within the European Union was made mandatory on 1st July 2003. Primarily intended for manufacturers of hazardous area equipment for use in the presence of flammable gases, vapours, fumes or dusts, the new directive requires a quality management system to be implemented.

Procedures for the design, manufacture and verification of products are to be approved by a notified body and all equipment conforming to the new directive will feature CE and Ex Marking.



Zone Classification with the presence of DUST

Zone 21	An area in which an explosive atmosphere in the form of a cloud of combustible dust in air is likely to occur in normal operation of the plant.
Zone 22	An area in which an explosive atmosphere in the form of a cloud of combustible dust in air is not likely to occur in normal operation, if it does occur, will persist for a short period only.

Zone Classification with the presence of GAS

Zone 1 (Categorie 2)	An area in which explosive gas is likely to be present during normal operation of the plant.
Zone 2 (Categorie 3)	An area in which explosive gas is not continuously present, but may exist for a short period of time.

Applicable Ex protection

<p>Ex e Protection for electrical components that do not spark under normal working conditions but where measures are applied to prevent high temperatures and the occurrence of arcs and sparks internally.</p>	
<p>Ex d Protection Parts, which can ignite a potentially explosive atmosphere, are surrounded by an enclosure, which are designed to withstand the pressure of an internal explosion and to prevent the propagation of the explosion to the atmosphere surrounding the enclosure.</p>	
<p>Ex m Protection Parts that could ignite a potentially explosive atmosphere by means of heat or sparks are embedded in a sealing compound such that the potentially explosive atmosphere cannot be ignited. The compound is resistant to physical, electrical, thermal and chemical influences.</p>	
<p>Protection Ex t The enclosure is enough seal so that no flammable dust can penetrate inside. The external surface temperature of the housing is limited.</p>	