



Gauge probes: spring push



Contact Gauging probes very often provide the only cost effective solution for a wide range of measuring or positioning applications in diverse industries.

As with all electromechanical transducers, life is of paramount importance. It is not too difficult to produce a Gauge Probe that performs well when new, it is considerably more difficult to produce a probe that maintains its performance throughout a long working life.

It requires close attention to detail in design and materials as well as considerable investment in state of the art machines to produce bearings, which are the heart of a gauge probe.

Solartron Metrology has complete control in house over all aspects for the design and manufacture of a wide range of linear bearing assemblies and sensors.

This is demonstrated very well in the DZ range, where a very short body length and increased performance has been made possible due to a unique sensor being mounted inside a special bearing.

Whether the application is in the laboratory or in a manufacturing environment, Solartron Metrology's extensive range of gauge probes has something suitable for a very wide range of environments.

Customised or special products will always be considered when there is not an exact fit in our standard product range.



Standard - DP

The Standard DP range of Spring Push Probes has justifiably become the workhorse of the gauging industry. Very high resolution, excellent linearity and high data speed come as standard. Long life precision bearings, and an IP65 rating ensure that probes maintain their performance for millions of cycles.



Compact - DZ

The DZ's are probably the shortest probes available on the market with a full 1mm or 2mm calibrated travel. A bearing size normally found only in much longer bodies ensures a long life. The small size coupled to enhanced linearity and resolution make them ideal where space is a problem.



Feather Touch - DT

With very low tip forces coupled with user selectable options of high resolution and data speed, Feather Touch Probes are ideal for the gauging of delicate high precision components. Long life bearings ensure that the performance of the probes are maintained through millions of cycles in industries producing high volumes of components on short cycle times.





	Short or Narrow Body					Standard				
Axial cable outlet	DZ/1/S	DZ/2/S	-	DP/1/S	D6P/2/S	DP/2/S	DP/5/S	DP/10/S	DP/20/S	DP10/2/S
Radial cable outlet	DZR/1/S	DZR/2/S	DP/0.5/S	-	-	DPR/2/S	-	DPR/10/S	DPR/20/S	-
Body diameter	8h6				6h6	8h6				
Measurement range (mm)	1	2	0.5	1	2	2	5	10	20	2
Pre-travel (mm)	0.15	0.15	0.03	0.15	0.15	0.15	0.15	0.15	0.15	0.15
Over travel (mm)	0.35	0.35	0.05	0.35	0.35	0.85	0.85	0.85	0.85	8.85
Accuracy (% of reading) ¹	0.05	0.05	0.05	0.05	0.05	0.05	0.05	0.06	0.07	0.05
Repeatability (µm)	0.15	0.15	0.1	0.15	0.15	<0.15				
Tip Force (N) @ centre travel	0.7 ± 20%					0.7 ± 20%				
Resolution (µm user selectable)	<0.01	<0.01	<0.01	<0.01	<0.01	<0.01	<0.05	<0.05	<0.1	<0.01
Data speed (user selectable)	Up to 3906 readings per second					Up to 3906 readings per second				
Environmental Protection	IP65 (Probe only)					IP65 (Probe only)				

	Feather Touch				
Axial cable outlet	DT/2/S	DT/5/S	DT/10/S	DT/20/S	DT10/2/S
Radial cable outlet	DTR/2/S	DTR/5/S	DTR/10/S	DTR/20/S	-
Body diameter	8h6				
Measurement range (mm)	2	5	10	20	2
Pre-travel (mm)	0.15	0.15	0.15	0.15	
Over travel (mm)	0.85	0.85	0.85	0.85	8.85
Accuracy (% of reading) ¹	0.05	0.05	0.06	0.07	0.05
Repeatability (µm)	<0.15				
Tip Force (N) @ centre travel	0.3 ± 20%				
Resolution (µm user selectable)	<0.01	<0.05	<0.05	<0.1	<0.01
Data speed (user selectable)	Up to 3906 readings per second				
Environmental Protection	IP50 (probe only)				

Temperature ranges (°C)	
Storage: probe + signal conditioning	-20 to +70
Operating: PIE / T-Con	0 to 60
Probe operating: (not Feather Touch)	+5 to +80
Probe operating: (Feather Touch)	-10 to +80

Materials	
Case	Stainless steel
Probe tip	Nylon or tungsten carbide
Gaiter	High grade polymer (none on Feather Touch)
Cable	2m PUR



Braided and armoured cable and special cable lengths are available on request

¹ Accuracy 1µm or % reading, whichever greater

Digital Probe interface electronics	
Bandwidth	Up to 460Hz
Output	Serial RS485 signal level, Solartron Orbit Protocol
Power (VDC)	5 ± 0.25@0.06A, includes power for probe
IP Rating	43 (65 available on request)
Weight (grams)	Probe interface electronics 52
	T connector 36
	DIN rail adaptor + T-Con 46

Also see...	
Dimensions and drawings	Page 24 ▶
Special probe tips	Page 34 ▶
Electronics / instrumentation	Page 18 ▶





Gauge probes: pneumatic push

Pneumatic Probes are ideal for use in automatic gauging applications or for accessing details that would be difficult or impossible to reach using conventional spring push probes.

With no side loading at the contact tip, Pneumatic probes also ensure excellent repeatability and long life.

Various component materials and designs are affected in different ways by the force applied at the point of contact at the probe tip. Some materials such as glass or plastic, for example, require very low tip forces to avoid deforming the component and contact tip materials that do not leave a mark. Other applications may require higher tip forces.



Standard range - DP

The Standard range of Pneumatic Probes comes with an IP65 rating to ensure a long working life in wet or oily environments.

In order to ensure the probe is totally sealed to IP65, actuation is achieved by pressurising the gaiter.

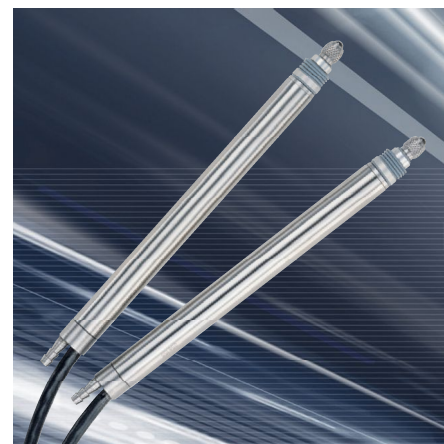

'J' Type - DJ

J' Type probes are similar to Standard Pneumatic Probes except that actuation is by an inbuilt piston. High tip forces are available but as air is vented through a port close to the front of the probe, they have a lower IP rating.



Feather Touch - DT

Feather Touch Probes are designed specifically for applications where low tip forces are critical.

Air is vented through the shroud at the front of the probe during actuation, which in turn cleans the bearing. With no gaiter to protect the shaft from contamination they are unsuitable for use in wet or oily conditions.



Ultra Feather Touch - UT

Ultra Light probes are similar to Feather Touch probes except they have a significantly lower moving mass and are capable of tip forces as low as 0.03N.





orbit3

	Standard					J' Type					
	DP/2/P	DP/5/P	DP/10/P	DP/20/P	DP10/2P	D6J/2/P	DJ/2/P	DJ/5/P	DJ/10/P	DJ10/2P	
Axial cable outlet											
Radial cable outlet	DPR/2/P	DPR/5/P	DPR/10/P	DP/20/P	DPR10/2P	-	DJR/2/P	DJR/5/P	DJR/10/P	DJR10/2P	
Body diameter	8h6					6H6	8h6				
Measurement range (mm)	2	5	10	20	2	2	2	5	10	2	
Pre-travel (mm)	0.15					0.15	0.15	0.15	0.15	0.15	
Over travel (mm)	0.85	0.85			8.85	0.35	0.85			8.85	
Accuracy (% of reading) ¹	0.05	0.05	0.06	0.07	0.05	0.05	0.05	0.05	0.06	0.06	
Repeatability (µm)	0.15					0.15					
Tip Force (N) @ centre travel ± 20%	0.8 @ 0.4 Bar, 2.8 @ 1 Bar	0.85 @ 0.4 Bar, 2.8 @ 1 Bar	0.7 @ 0.4 Bar, 2.5 @ 1 Bar			1.15@1bar	0.85 @ 1Bar ± 20%				
Resolution (µm user selectable)	<0.01	<0.05	<0.05	<0.1	<0.01	<0.01	<0.01	<0.05	<0.05	<0.05	
Data speed (user selectable)	Up to 3906 readings per second					Up to 3906 readings per second					
Environmental Protection	IP65 (probe only)					IP50 (probe only)					

	Feather Touch				Ultra Feather Touch
	DT/2/P	DT/5P	DT/10/P	DT/20P	
Axial cable outlet					
Radial cable outlet	DTR/2/P	DTR/5/P	DTR/10/P	DTR/20/P	
Body diameter	8h6				8h6
Measurement range (mm)	2	5	10	20	10
Pre-travel (mm)	0.15				0.15
Over travel (mm)	0.85				0.85
Accuracy (% of reading) ¹	0.05	0.05	0.06	0.07	0.06
Repeatability (µm)	0.15				0.15
Tip Force (N) @ centre travel	0.18 @ 0.3 Bar, 1.1 @ 1 Bar ± 30%				0.03 - 0.05 @ 0.4 bar
Resolution (µm user selectable)	<0.01	<0.05	<0.05	<0.1	<0.01
Data speed (user selectable)	Up to 3906 readings per second				
Environmental Protection	IP50 (probe only)				

Temperature ranges (°C)	
Storage: probe + signal conditioning	-20 to +70
Operating: PIE / T-Con	0 to 60
Probe operating: (not Feather Touch)	+5 to +80
Probe Operating: (Feather Touch)	-10 to +80

Materials	
Case	Stainless steel
Probe tip	Nylon or tungsten carbide
Gaiter	High grade polymer (none on Feather Touch)
Cable	2m PUR



Braided and armoured cable and special cable lengths are available on request

¹ Accuracy 1µm or % reading, whichever greater

Digital Probe interface electronics	
Bandwidth	Up to 460Hz
Output	Serial RS485signal level, Solartron Orbit Protocol
Power (VDC)	5± 0.25@0.06A, includes power for probe
IP Rating	43 (65 available on request)
Weight (grams)	Probe interface electronics 52
	T connector 36
	DIN rail adaptor + T-Con 46

Also see...	
Dimensions and drawings	Page 26 ▶
Special probe tips	Page 34 ▶
Electronics / instrumentation	Page 18 ▶





Specialist gauging products



Solartron's specialist gauging products are for applications where a standard pencil style probe for various reasons won't fit.

They are primarily motion changers or mechanical interfaces that sit between the component and measuring sensor.

Special care has to be applied in the design and manufacture of all mechanical interfaces where the contact point is not in line with or may be some distance from the sensor.

Unmeasured movement that is often seen for example in classic bell arm lever type motion changers, is a major cause of poor gauge R&R. All Solartron specialist gauging products are specifically designed to ensure long life and consistent repeatability.

Block Gauges have precision linear bearings with zero clearance which limits unmeasured movement and therefore maintains good repeatability, even when the contact tip is mounted off centre.

Flexures have no sliding components within the gauge frame and no contacting moving components within the sensor. This means that millions of cycles are achievable without degradation of performance.

The miniature flexures within Mini Probes are particularly robust on both axes of loading.

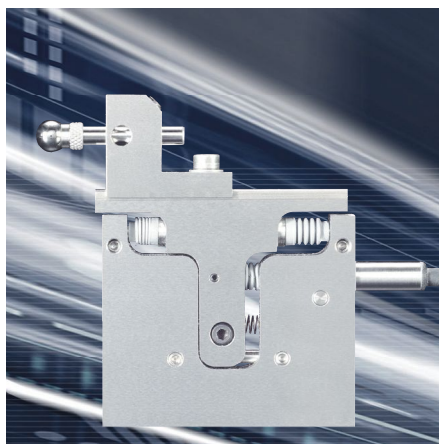

Block gauge - DK

Block Gauges make precision measurements of bores and cavities a simple and reliable process. A range of springs is available to ensure that tip forces can be maintained with the Block gauge mounted in any attitude. Pneumatic actuators can be retrofitted for automatic applications.



Flexure - DU

Flexures are ideal for very high volume and high precision applications such as bearing component gauging. They are often the best solution for measuring moving material, such as roundness testing, with Orbit set to very high resolution and fast data transmission.



Mini probe - DM

The Mini Probe is a very robust miniature flexure with all the attributes of its bigger brother. It's particularly useful in all aspects of bore gauging where high accuracy and durability are required. A range of customer fit contact tips are available to suit most gauging applications.



Lever probe - DL

Lever probes are generally used for precision gauging of components, such as shafts, for profiling but the Orbit compatible Lever Probe is not restricted to such applications. The narrow body (compared to such devices based on dial test indicators) coupled with a gentle touch down to 0.05N enables access to difficult to reach details, even on fragile components.





orbit3

Block Gauge			
Axial cable outlet	DK/2	DK/5	DK/10
Radial cable outlet	DKR/2	DKR/5	DKR/10
Measurement range (mm)	2	5	10
Total mechanical travel (mm)	3	6	11
Accuracy (% of reading) ¹	0.05	0.05	0.08
Repeatability (μm) @0.7 N tip force	0.25	0.25	0.5
Tip force (N) at centre of travel (horiz. attitude) ±20%	1.5	1.5	1.5
Mass of moving parts (g) less tool holder	35	90	95
Temperature coefficient (μm/°C)	±0.2	±0.5	±1.0
Environmental protection	IP65		

Tip force is affected by mounting attitude and weight of accessories. Tip force can be adjusted higher or lower using a selection of springs. Tip force depends on the weight of accessories + the selected springs + air pressure. See page 28 for tool and tip holders, springs and pneumatic actuators.

Mini Probe	DM/0.5/S		DM/1.0/S	
	on axis	cross axis	on axis	cross axis
Measurement range (mm)	0.5		1	
Accuracy (% of reading) ¹	0.20		0.2	
Repeatability (μm)				
...at 100μ from limit stop	0.1	0.1	0.1	0.1
...at 250μ from limit stop	0.25	0.15	-	-
...at 500μ from limit stop	0.5	0.25	0.15	0.1
...at 1000μ from limit stop	-	-	0.3	0.15
Tip force (at centre of range) (N)	0.7 ±25%			
Temperature coefficient (μm/°C)	0.08			
Tip adjustment (mm)	±0.25 from the factory position. Refer to manual			
Mounting	1x M3 hex head screw (supplied)			

¹ Accuracy 1μm or % reading, whichever greater

Digital Probe interface electronics	
Bandwidth	Up to 460Hz
Output	Serial RS485 signal level, Solartron Orbit Protocol
Power (VDC)	5 ± 0.25@0.06A, includes power for probe
IP Rating	43 (65 available on request)
Weight (grams)	Probe interface electronics 52 T connector 36 DIN rail adaptor + connector 46

Flexure Gauge	
Axial cable outlet	DU/2/S
Radial cable outlet	DU/2/R
Measurement range (mm)	2
Total mechanical travel (mm)	2.5
Accuracy (% of reading) ¹	0.05
Repeatability (μm) @0.7 N tip force	0.1
Tip force (N) at centre of travel (horiz. attitude)	1.5
Environmental protection	IP65

Lever Probe	
Measurement range (mm)	0.5
Mechanical travel (mm)	0.6
Stylus adjustment	180°
Accuracy (% of reading) ¹	0.2
Repeatability (μm) (on axis)	<0.15
Hysteresis (μm)	<0.25
Tip force (N) in 0.05N increments	0.05 - 0.3
Temperature coefficient	0.1μm/°C

Temperature ranges (°C)	
Storage (all)	-20 to +70
Operating (all)	5 to 60

Materials	
Body / frame	Stainless steel (not mini probe)
Probe tip	various options
Gaiter	High grade polymer (not lever probe)
Cable	2m PUR (not mini probe - see P29)

Also see...	
Dimensions and drawings	Page 27 ▶
Special probe tips	Page 34 ▶
Electronics / instrumentation	Page 18 ▶





Dimensions (mm): Spring push gauge probes



Standard Spring Push (DP/S)

	DP/2/S	DP10/2/S	DP/5/S	DP/10/S	DP/20/S
A	47.50	75.00	66.50	90.50	127.00
C	2.00	4.00	2.00	2.00	3.00
B1	13.90	25.40	17.40	25.40	44.90
B2	10.90	14.40	11.40	14.40	23.90

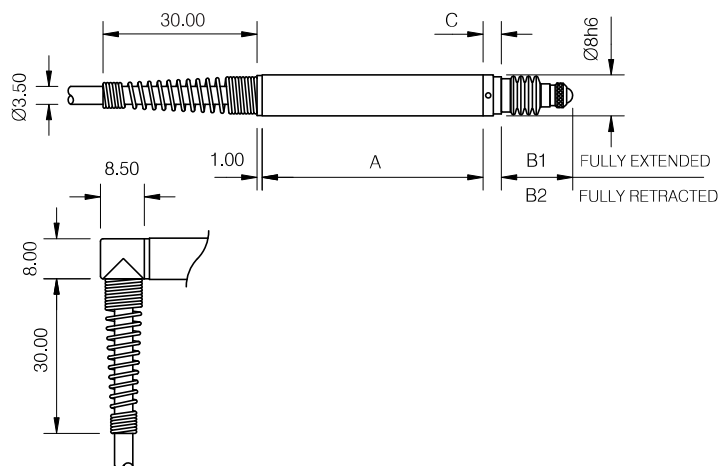

Right Angle Standard Spring Push (DP/R)

Plastic adaptor kit turns cable through 90° where axial space is limited.

Feather Touch Spring Push (DT/S)

	DT/2/S	DT/5/S	DT/10/S	DT/20/S
A	47.50	66.50	90.50	127.00
C	2.00	2.00	2.00	3.00
B1	13.90	17.40	25.40	33.90
B2	10.90	11.40	14.40	12.90

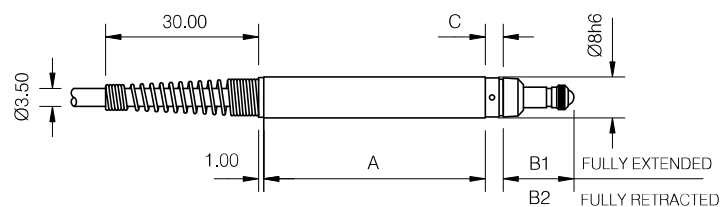

Right Angle Feather Touch Spring Push (DTR/S)

	DTR/2/S	DTR/5/S	DTR/10/S	DTR/20/S
A	33.50	52.50	76.50	113.50
C	2.00	2.00	2.00	3.00
B1	13.90	17.40	25.40	33.90
B2	10.90	11.40	14.40	12.90

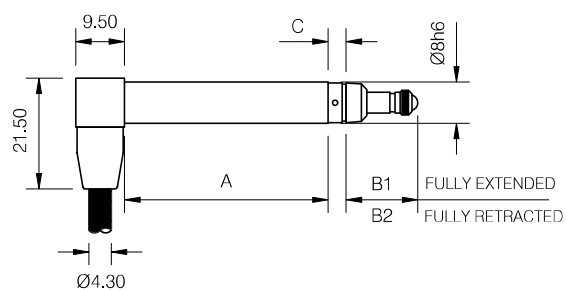

Vacuum Retract (DPV)

	DP/2/V	DP/5/V	DP/10/V	DP/20/V
A	46.00	65.00	96.00	127.00
C	2.00	2.00	2.00	3.00
B1	13.90	17.40	25.40	44.90
B2	10.90	11.40	14.40	23.90

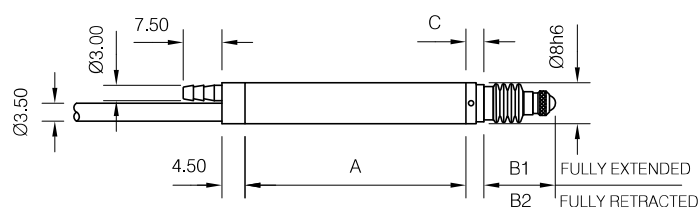



Dimensions (mm): Spring push gauge probes

orbit3

Compact Spring Push (DZ/S) Right Angle Compact Spring Push (DZR/S)

DZ/S

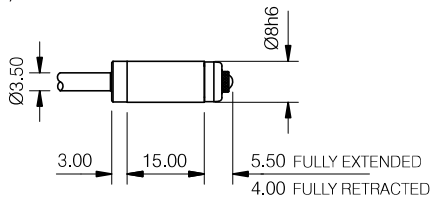

DZ/S

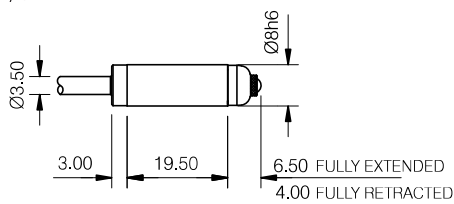

DZ/S

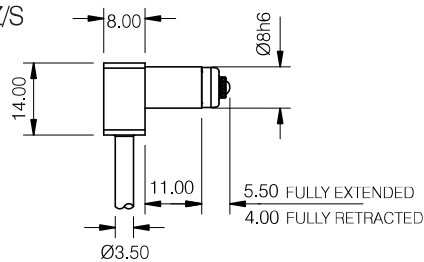

DZ/S

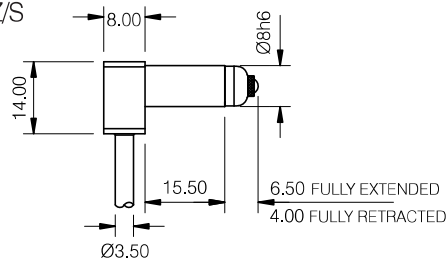

Slim 6mm Ø Spring Push (D6P/2/S)

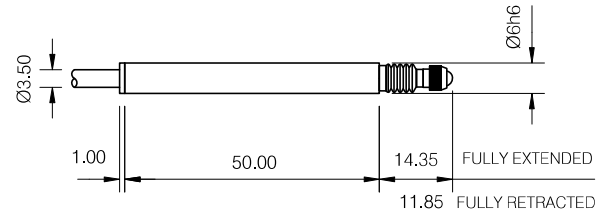

Ultra Short Spring Push (DP1/S)

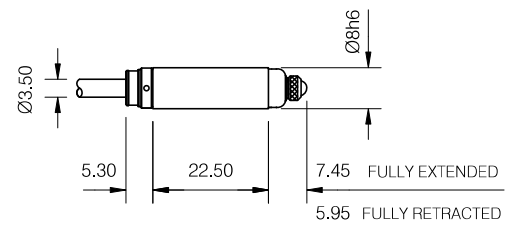

Ultra Small Spring Push (DP/0,5/S)

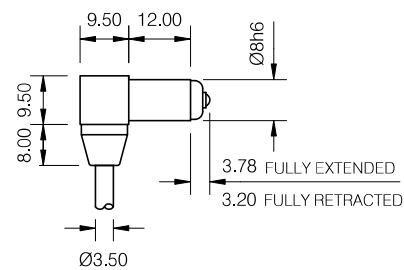



Dimensions (mm): Pneumatic push gauge probes



Pneumatic Push (DP/P)

	DP/2/PE	DP/2/P	DP/5/P	DP/10/P	DP/20/P
A	84.00	52.50	71.00	96.00	127.00
C	2.00	2.00	2.00	2.00	3.00
B1	25.40	13.90	17.40	25.40	44.90
B2	14.40	10.90	11.40	14.40	23.90

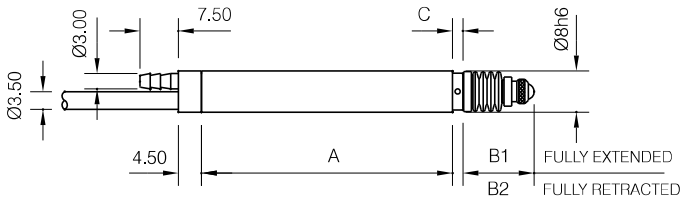

Feather Touch Pneumatic Push (DT/P)

	DT/2/P	DT/5/P	DT/10/P	DT/20/P
A	52.50	71.00	96.00	127.00
C	2.00	2.00	2.00	3.00
B1	13.90	17.40	25.40	33.90
B2	10.90	11.40	14.40	12.90

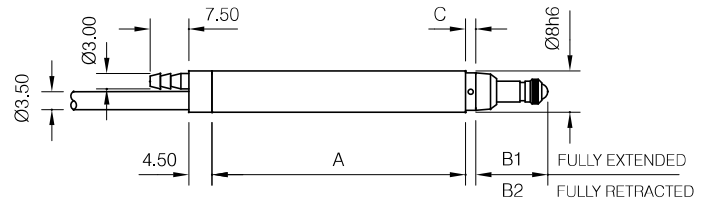

Right Angled Pneumatic Push (DTR/P)

90° output/ non braided cable

	DTR/2/P	DTR/5/P	DTR/10/P	DTR/20/P
A	38.50	57.50	82.50	113.50
C	2.00	2.00	2.00	3.00
B1	13.90	17.40	25.40	33.90
B2	10.90	11.40	14.40	12.90

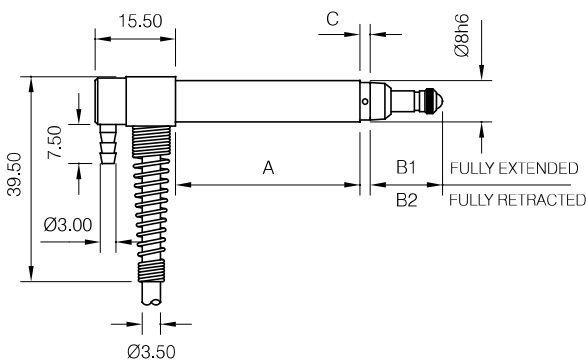

Right Angled Feather Touch Pneumatic Push (DTR/P)

90° output/ braided cable

	DTR/2/P	DTR/5/P	DTR/10/P	DTR/20/P
A	38.50	57.50	82.50	113.50
C	2.00	2.00	2.00	3.00
B1	13.90	17.40	25.40	33.90
B2	10.90	11.40	14.40	12.90

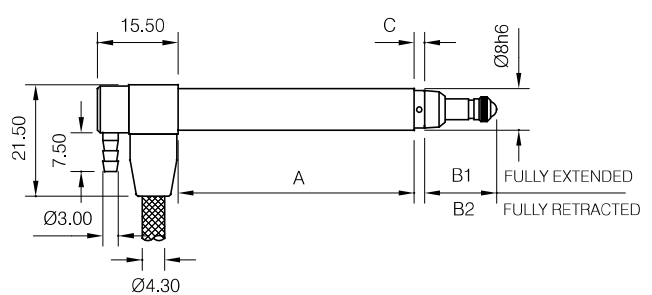

Gaiter Independent Slim 6mm Ø Pneumatic Push (D6J/2/P)

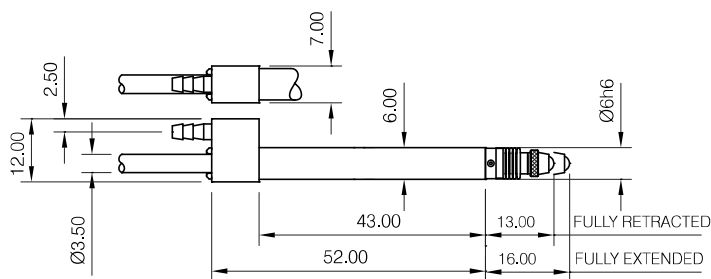

Gaiter Independent Pneumatic Push (DJ/P)

	DJ/2/P	DJ10/2/P	DJ/5/P	DJ/10/P
A	52.0	84.0	71.0	96.0
C	7.0	7.0	7.0	7.0
B1	15.4	26.9	18.9	26.9
B2	12.4	15.9	12.9	15.9

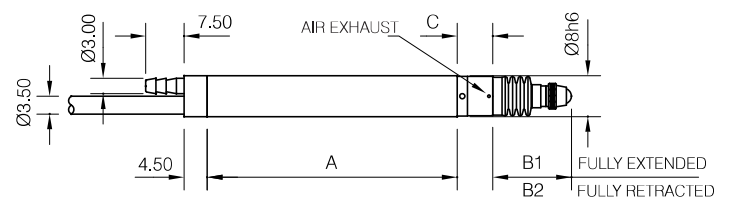

Ultras Feather Touch Pneumatic Push (UT/10/P)

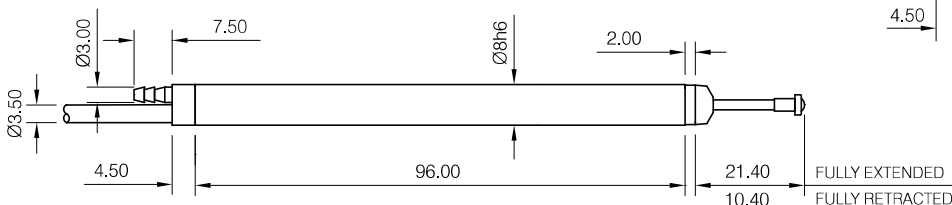



Dimensions (mm): Specialist gauge probes



Block gauge 2mm

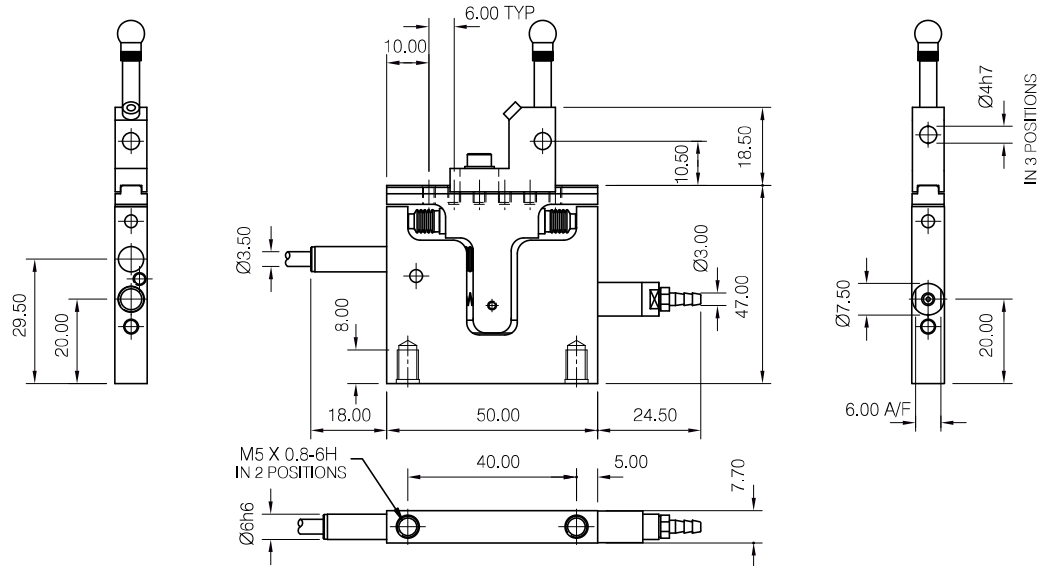

Block gauges 5mm and 10mm

	5mm	10mm
A	74.50	90.00
B	60.00	75.00
C	30.00	45.00

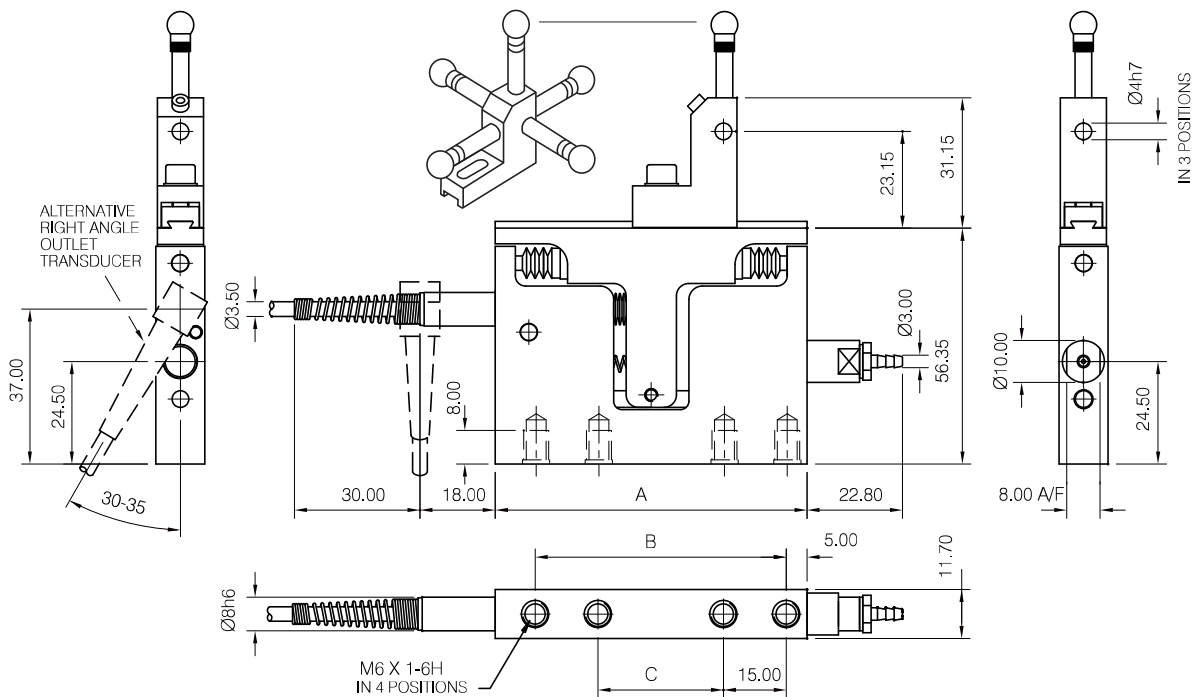

Block gauge configurations

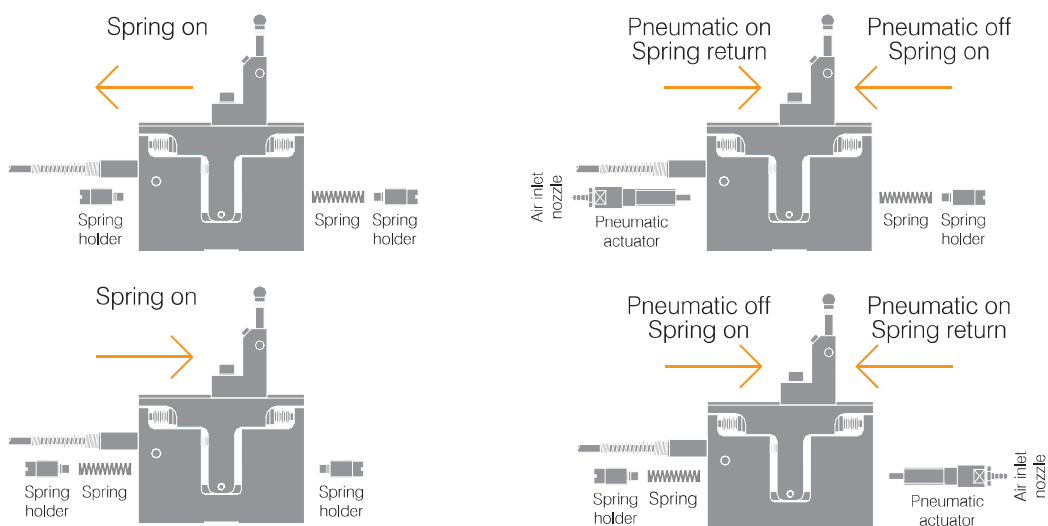



Dimensions (mm): Specialist gauge probes



Mini probe 0.5mm

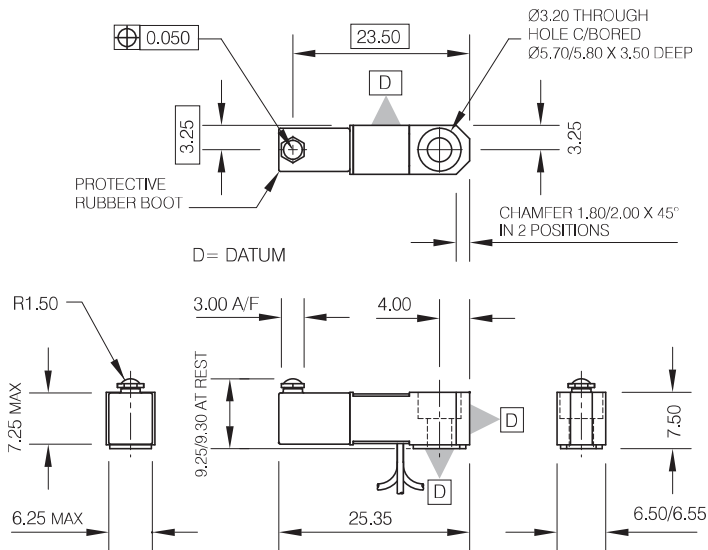

Mini probe 1.00mm

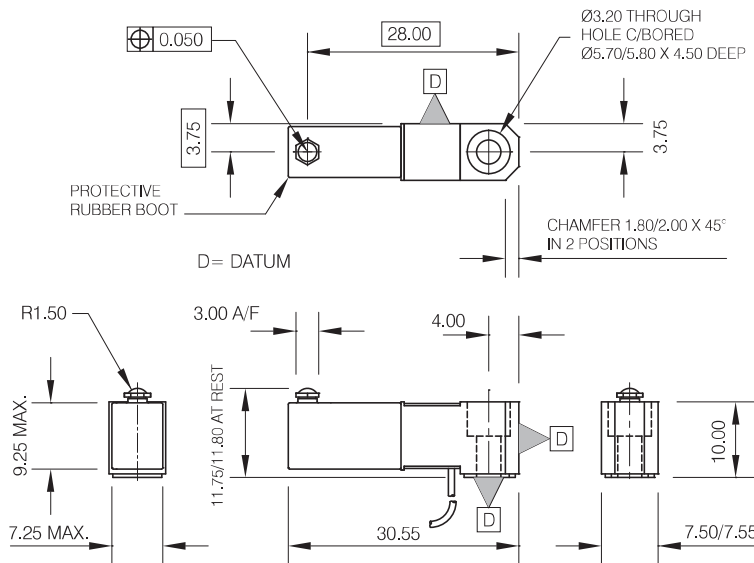

Mini probe tips

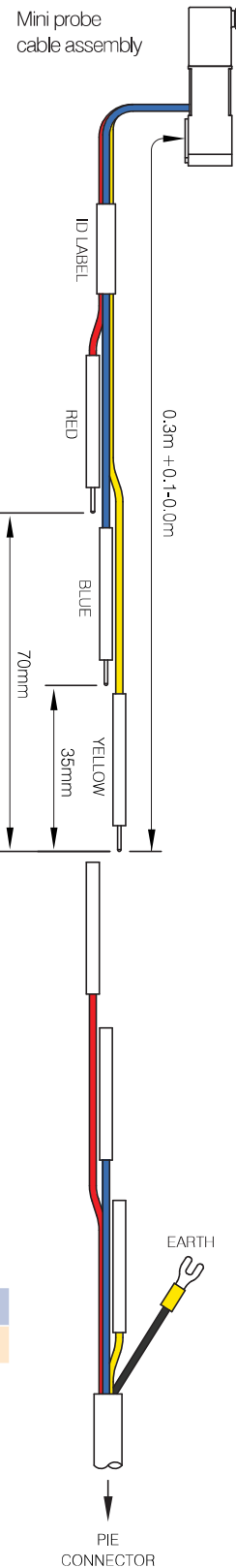
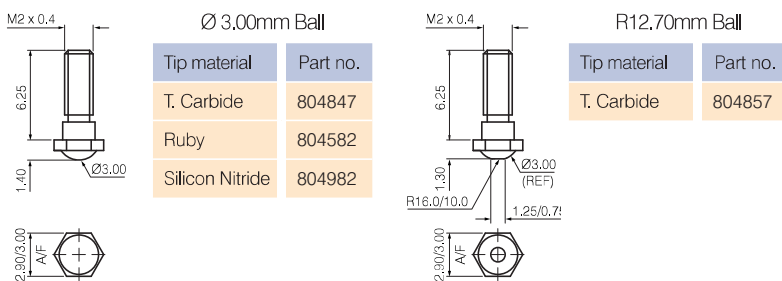

Lever probe

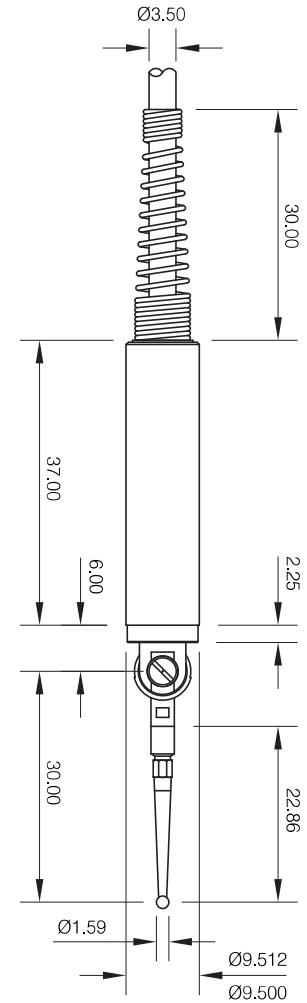

Mounting blocks

The lever probe can be clamped directly into a 9.52 mm mounting hole. Alternatively the following mounting blocks are available;

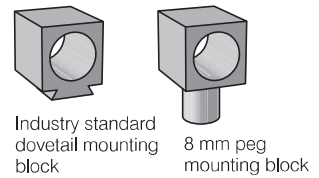

Ball tipped styli

Lever probe styli are available in a range of ball diameters. All have 1-75 UNF mounting threads.

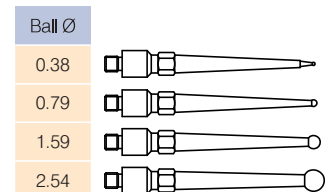



Probe tips



- 1 Type normally fitted to AX Series and tungsten carbide version of feather touch probes
- 2 Shank of 041676 is narrower and longer than 802605. Tip normally used on linear encoders
- 3 Type fitted to nylon versions of feather touch probes

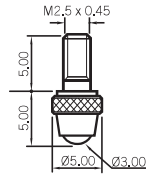

Ø3.00mm Ball

Tip material	Part no.
T. Carbide	804979
Ruby	804807
Nylon	805181
Silicon Nitride	804973

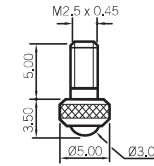

Ø3.00mm Ball

Tip material	Part no.
T. Carbide	802605 ¹
Nylon	803246 ³

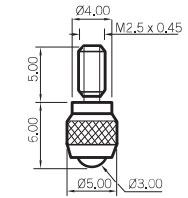

Ø3.00mm Ball

Tip material	Part no.
T. Carbide	041676 ²

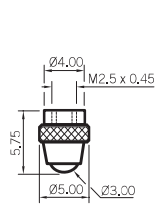

Ø3.00mm Ball

Tip material	Part no.
T. Carbide	804967
Ruby	804966
Nylon	804965
Silicon Nitride	805180

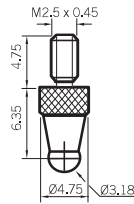

Ø3.18mm Ball

Tip material	Part no.
T. Carbide	008305-004

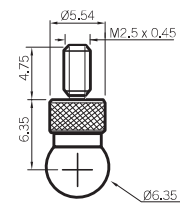

Ø6.35mm Ball

Tip material	Part no.
T. Carbide	008305-005

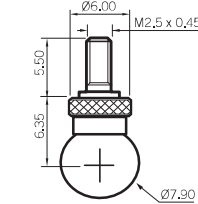

Ø7.90mm Ball

Tip material	Part no.
Ruby	804828

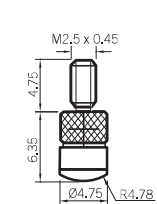

Ø4.75mm Dome

Tip material	Part no.
T. Carbide	008305-034

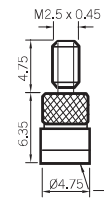

Ø4.75mm Flat

Tip material	Part no.
T. Carbide	008305-033

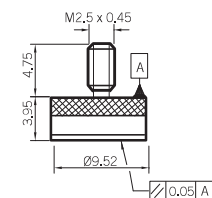

Ø9.52mm Flat

Tip material	Part no.
T. Carbide	008305-007

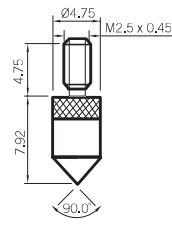

90° Tip

Tip material	Part no.
T. Carbide	008305-003

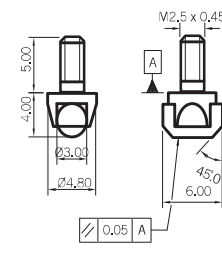

Ø7.90mm Roller

Tip material	Part no.
T. Carbide	008305-030

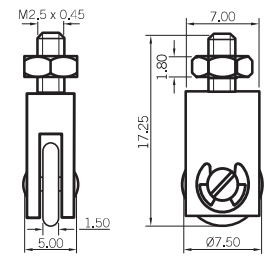

1.5 x Ø7.50mm Wheel

Tip material	Part no.
Steel	008305-027

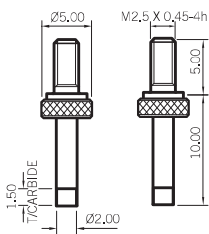

Ø2.00mm Pin

Tip material	Part no.
T. Carbide	206675

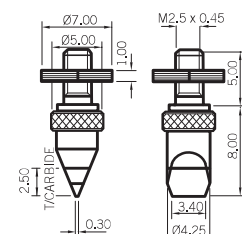

Knife Edge

Tip material	Part no.
T. Carbide	206674

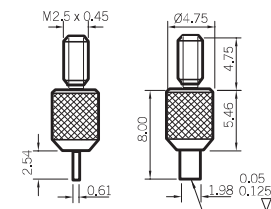

0.6 x 2mm Blade Edge

Tip material	Part no.
T. Carbide	008305-035

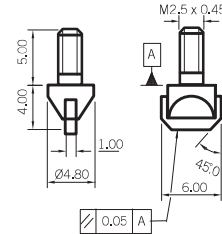

1 x 6mm Blade Edge

Tip material	Part no.
T. Carbide	008305-031

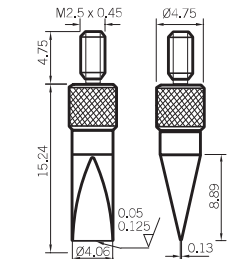

4 x 11mm Knife Edge

Tip material	Part no.
T. Carbide	008305-036

