



# RECIPROCATING FUEL PUMPS

## FRA, FRD



### FRA MODEL UNIQUE FEATURES

For applications where low cost and good durability are required.

- Flow: to 190 lph (52 gph)
- Continuous duty life (diesel fuel): >5000 hrs
- Weight: 0.74 kg (1.63 lbs)
- Pump cycles continuously when power is on

### FRD MODEL UNIQUE FEATURES

For applications where battery life, low noise and better durability are important.

- Flow: to 210 lph (55 gph)
- Current draw: up to 70% less than FRA & FRC
- Weight: 0.75 kg (1.65 lbs)
- Continuous duty life (diesel fuel): >10000 hrs
- Pump cycles only when fuel is demanded

## FRB, FRC



### FRB MODEL UNIQUE FEATURES

For applications where battery life, low noise and best durability are important. An in-pump fuel filter increases pump life if operated under dirty-fuel conditions.

- Flow: to 225 lph (60 gph)
- Current draw: up to 70% less than FRA & FRC
- Continuous duty life (diesel fuel): >18000 hrs
- Weight: 0.83 kg (1.83 lbs)
- Pump cycles only when fuel is demanded
- Replaceable filter

### FRC MODEL UNIQUE FEATURES

For applications where low cost and better durability are important. An in-pump fuel filter increases pump life if operated under dirty-fuel conditions.

- Flow: to 210 lph (55 gph)
- Continuous duty life (diesel fuel): >10000 hrs
- Weight: 0.83 kg (1.83 lbs)
- Pump cycles continuously when power is on
- Replaceable filter

## STANDARD FEATURES- ALL MODELS

- Current requirement: < 2 amps average
- Reverse polarity protected up to 60 minutes
- Self priming (dry lift) of more than 120cm (48")
- Dry run to four (4) hours
- Compatible with all commercially available pump grade gasoline, gasohol, diesel or bio-diesel
- Operating temperature: -40 ~ +70C (-40 ~ +155F)
- Transient voltage protected to 100 volts
- Tested per CFR Title 33: 183.590 Fire Test and 183.410 Ignition Protection (USCG)







## CONFIGURATION OPTIONS AVAILABLE

Option	FRA	FRB	FRC	FRD
12 volt	X	X	X	X
24 volt	X	X	X	X
Lead wires, connectors and electrical ground (see notes 1 & 2)	A, B, C	A	A, B, C	A
Output pressure: 20 kpa (3 psi)	X	X	X	X
Output pressure: 35 kpa (5 psi)	X	X	X	X
Output pressure: 50 kpa (7 psi)	X	X	X	X
Output pressure: 70 kpa (10 psi)	X	X	X	X
Output pressure: 90 kpa (13 psi)	X	X	X	X
Self priming (dry lift) of more than 305cm (120") (see note 3)	X	X	X	X
Standard external finish (meets ASTM B-117 (96) hr salt spray)	X	X	X	X
Marine external finish (meets ASTM B-117 (1000) hr salt spray)	X	X	X	X
Bowl drain (see Figures 1 and 3)		X	X	
Transparent fuel bowl- not USCG approved (see Figure 2)		X	X	
Inlet filter: 70 micron		X	X	
Inlet filter: 420 micron		X	X	
Magnetic trap		X	X	
Inlet fuel fitting thread- 1/8-27 NPSF	X	X	X	X
Inlet fuel fitting thread- 1/4-18 NPSF		X	X	
Outlet fuel fitting thread- 1/8-27 NPSF	X	X	X	X
Outlet fuel fitting thread- 1/4-18 NPSF	X	X	X	X
Internal outlet check valve (available with 1/8-27 NPSF only)	X	X	X	X
External outlet check valve - 1/8-27 NPSF (see Figure 4)	X	X	X	X
External outlet check valve - 1/4-18 NPSF (see Figure 4)	X	X	X	X
Straight fuel fitting: 1/4-18 NPSF to 5/16 hose barb (see Figure 5)	X	X	X	X
45° fuel fitting: 1/8-27 NPSF to 5/16 hose barb (see Figure 6)	X	X	X	X
45° fuel fitting: 1/4-18 NPSF to 5/16 hose barb (see Figure 6)	X	X	X	X
90° fuel fitting: 1/8-27 NPSF to 5/16 hose barb (see Figure 7)	X	X	X	X
90° fuel fitting: 1/4-18 NPSF to 5/16 hose barb (see Figure 7)	X	X	X	X
Mounting (see "MOUNTING AND FITTING LOCATIONS AND DETAILS")	F or G	F or G	F or G	F or G
Fitting location (see "MOUNTING AND FITTING LOCATIONS AND DETAILS")	H, J	H, K	H, K	H, J

## Notes:

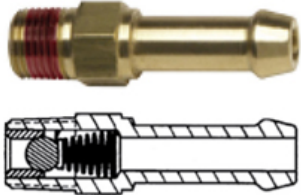
1. Lead wire and electrical ground options
  - A. Two wire: Must be battery or vehicle grounded by customer, does not have internal ground (Body must be externally grounded for gasoline applications)
  - B. Two wire: Must be battery or vehicle grounded by customer and includes internal ground (Suitable for gasoline)
  - C. One wire: Pump must be battery or vehicle grounded by customer and includes internal ground (Suitable for gasoline)
2. Lead wire lengths and electrical connectors per customer requirement
3. Requires standard inlet and outlet valves and an optional outlet check valve

## FIGURES - CONFIGURATION OPTIONS AVAILABLE

<p><b>Figure 1</b> Fuel Bowl Drain</p> 	<p><b>Figure 2</b> Transparent Fuel Bowl</p>  <p>NOTE: For OE Applications only</p>	<p><b>Figure 3</b> Transparent Fuel Bowl Drain</p>  <p>NOTE: For OE Applications only</p>	<p><b>Figure 4</b> Part # 128-3202: Straight 1/8-27 NPTF to 5/16 Hose Barb w/Check Valve or Part # 128-3220: 1/4-18 NPTF to 5/16 Hose Barb w/Check Valve</p> 
<p><b>Figure 5</b> Part # 128-3005: Straight 1/4-18 NPTF to 5/16 Hose Barb Fuel Fitting</p> 	<p><b>Figure 6</b> Part # 128-120: 45° 1/8-27 NPTF to 5/16 Hose Barb Fuel Fitting or Part # 128-3064 45° 1/4-18 NPTF to 5/16 Hose Barb Fuel Fitting</p> 	<p><b>Figure 7</b> Part # 128-3094: 90° 1/8-27 NPTF to 5/16 Hose Barb Fuel Fitting or Part # 128-3061 90° 1/4-18 NPTF to 5/16 Hose Barb Fuel Fitting</p> 	

## OVERALL DIMENSIONS, MOUNTING DETAILS AND FITTING LOCATIONS

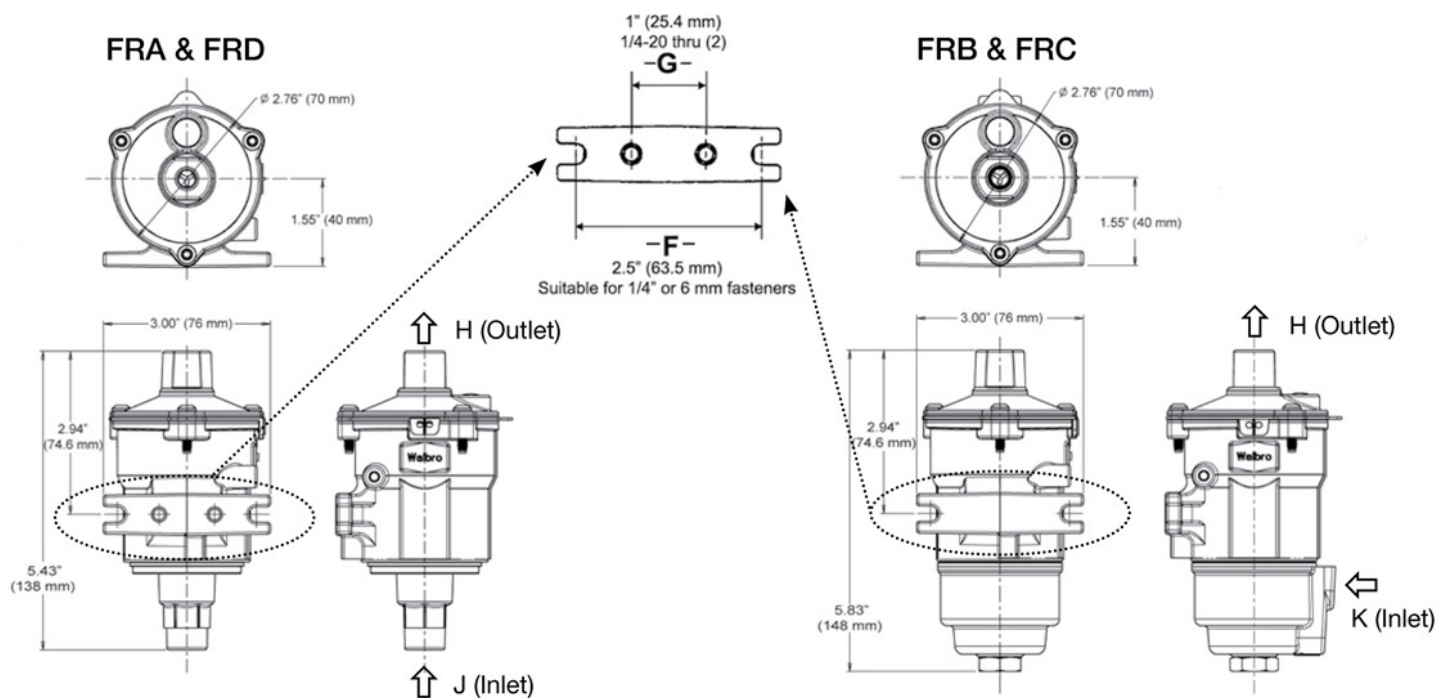

## FUEL PUMP SIZING GUIDELINES

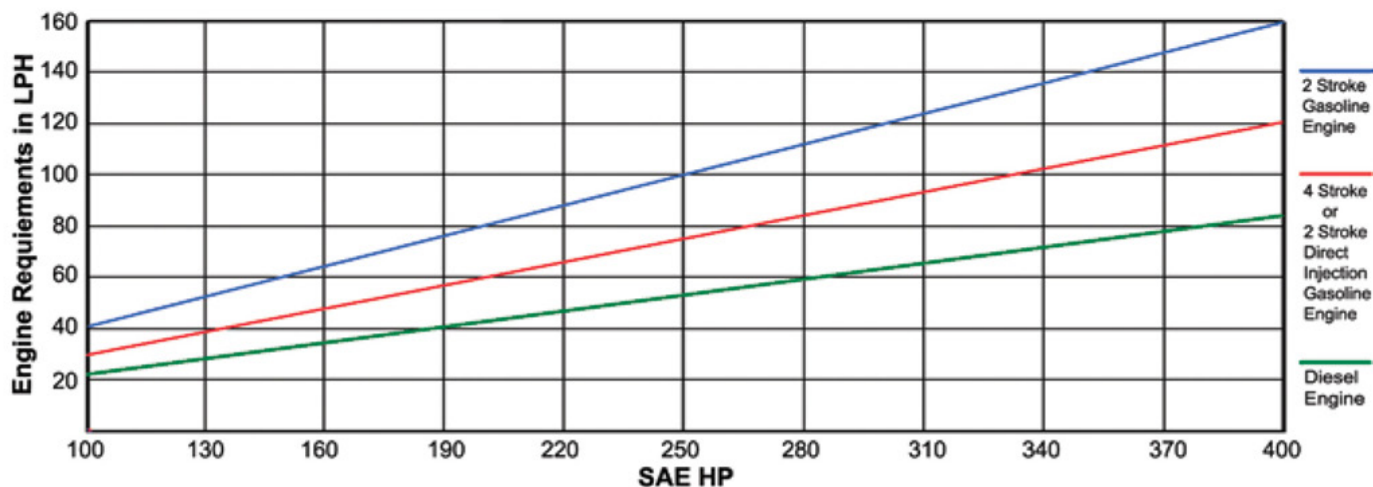
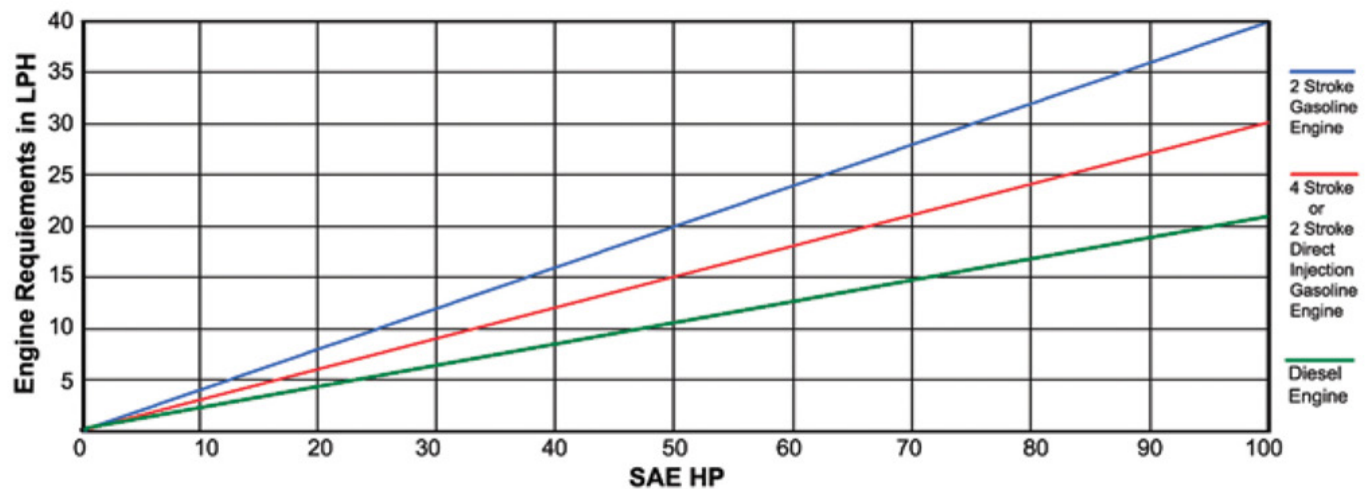

## To calculate pump size requirements:

1. Engine fuel requirements (in lph) shown in the above charts is an approximation based on the following calculation:
  - a. Two Stroke engines =  $(HP)(.40)$  (based on BSFC of  $.67\#/HP/HR$ )
  - b. Four stroke or direct injected two stroke engines =  $(HP)(.30)$  (based on BSFC of  $.50\#/HP/HR$ )
  - c. Diesel engines =  $(HP)(.25)$  (based on BSFC of  $.42\#/HP/HR$ )
2. Consider an additional hot fuel (for gasoline applications) allowance of up to 30% (application specific)
3. Consider an additional fuel allowance for injector pump cooling (diesel applications only)
4. Consider an additional safety allowance for certain applications where fuel lines, filters, etc. create abnormal pressure losses (confirmation by testing recommended)
5. For additional application assistance, contact Walbro Engine Management



**Walbro, LLC**  
**Worldwide Headquarters**

2015 W. River Road, Ste 202  
Tucson, Arizona 85704 USA  
Telephone (520) 877-3000

Website: [www.walbro.com](http://www.walbro.com)

Email: [info@walbro.com](mailto:info@walbro.com)

**Walbro US Sales Office**

Email: [sales@walbro.com](mailto:sales@walbro.com)

**Walbro Japan Sales Office**

Email: [asiasales@walbro.com](mailto:asiasales@walbro.com)

**Walbro China Sales Office**

Email: [chinasales@walbro.com](mailto:chinasales@walbro.com)