

SF100DP

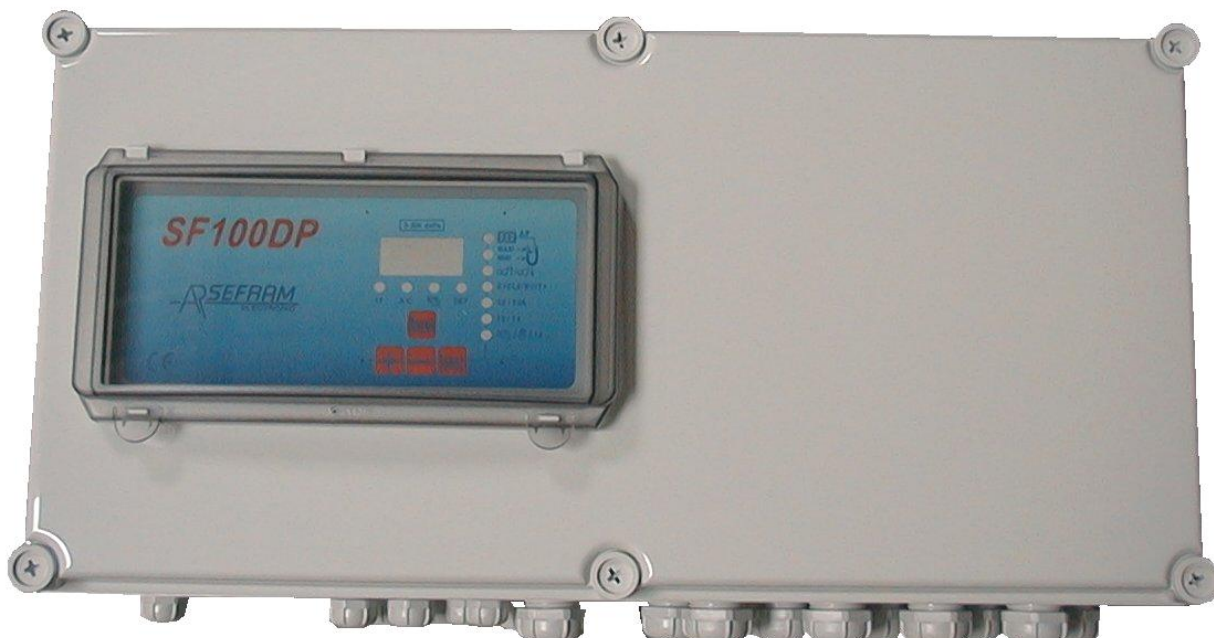

The SF100DP is designed to manage dust removal filters which are unclogged by compressed air.

It performs the following functions:

- dust removal sequence,
- measurement of the filter load loss and associated checks (optional)
- compressed air control in association with an external pressure switch. (optional)
- dust removal after the unit has been switched off.

SPECIFICATIONS

N.B.: the greyed areas are options.

◆ Supply voltage	115/230V 50 Hz as standard On request: 24/48V 50 Hz
◆ Consumption	8VA + consumption of the SV
◆ External SV voltage	Same as supply voltage or integrated 24V 50 Hz 40VA or 24V DC 40W
◆ Current on one output	24 V internal Mains supply
◆ Specifications of the inputs	1.6A max holding 2A max holding
◆ Specifications of the relay contacts	Voltage: 24V DC supplied by the unit Charging current: +/- 10 mA 1A AC1 250V 50 Hz (to be protected by the user)

SEQUENCER:

◆ Max number of SVs	4 unit configurations -40 SV -60 SV -80 SV -100 SV
◆ Pulse time T1	3/100 th - 255/100 th of a second
◆ Idle time between 2 blasts (T2 or T2A)	1 - 255 seconds
◆ Time between 2 cycles T3	0 - 255 minutes
◆ Forced dust removal time T4	0 - 255 hours
◆ Fan stopped cleaning	0 - 255 cycles
◆ Manual operation	0 - 255 cycles

DP MEASUREMENT:

◆ Scale	0-500 daPa as standard Other on request
◆ Test pressure	750 mbar
◆ Destructive pressure	1000 mbar)
◆ Humidity of measurable fluids	100% RH
◆ Measurable fluids	Non corrosive, non aqueous
◆ Nature of the materials in contact with the fluid	Glass filled nylon, ceramic Al ₂ O ₃ , RTV silicon, etc
◆ Accuracy	Class 2 (on sensor max scale 1000 daPa)
◆ 4-20 mA	Active, max load ≤ 500Ω, not isolated

◆ Operating temperature	0 to +65°C
◆ Storage temperature	-20° to +70°C
◆ Usage position	Vertical
◆ Unit protection	With 5x20 size fuses
◆ Unit	Polycarbonate, IP65 protection IK 07

PRESENTATION OF THE FRONT PANEL

OPTIONAL (NOTE 1)

Adjustements associated to load loss Measurement.

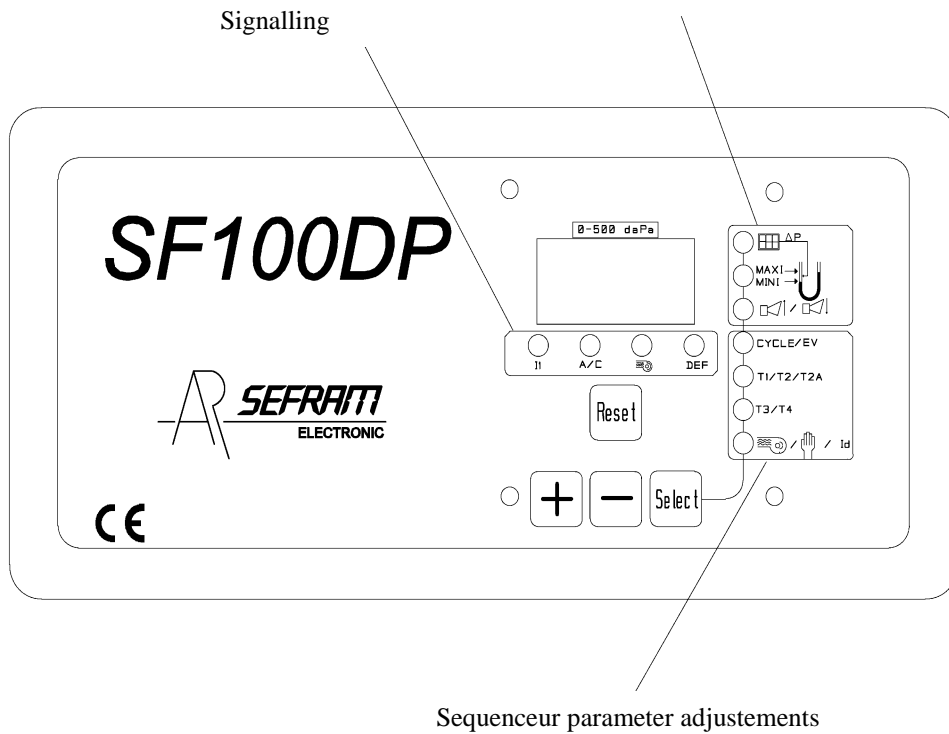

Note 1 : If the load loss measurement option is not validated by the presence of the sensor card in the unit, the front panel emains the same but the steps of the select menu associated to the load loss measurement are not accessible.

Function location:

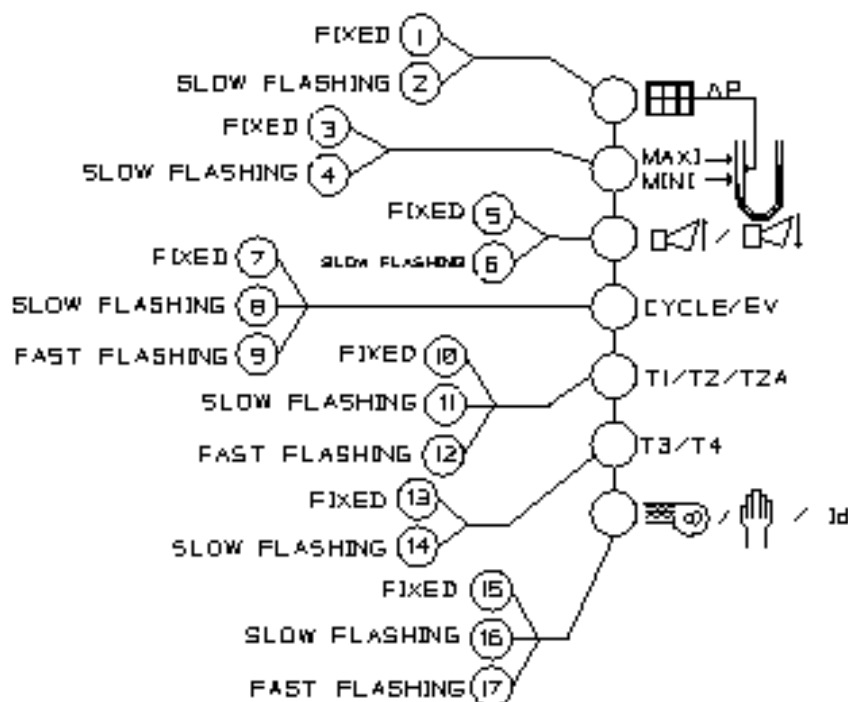

Adjustments:

1) DP measurement display:

Displays the DP measurement.

If a fault is present, the fault type is displayed alternately.

If DP = 1, "Max DP/Min DP" menu LED flashes rapidly

If high or low alarm reached, "High alarm/Low alarm" menu LED flashes rapidly.

If + button pressed, nxx displayed where xx = SV which will be operated for next blast

2) DP control selection:

Select "AdP" or "SdP".

"AdP": for cycle linked to DP measurement.

"SdP": for cycle not linked to DP measurement.

3) Max DP adjustment:

If the DP measurement exceeds this threshold for more than a second, dust removal starts (if cycle is linked to DP measurement).

4) Min DP adjustment:

If the DP measurement falls below the DP threshold for more than a second, dust removal stops (if cycle is linked to DP measurement).

Note: If Max DP=Min DP=000, then DP is forced to 1

5) High DP Alarm Adjustment:

If the DP measurement goes above this threshold for more than 5 seconds --> high DP alarm.

If the DP measurement goes below this threshold for more than 5 seconds --> no high DP alarm.

Note: if the high DP alarm is set to 000, it is inactive.

6) Low DP Alarm Adjustment:

If the DP measurement goes below this threshold for more than 5 seconds --> low DP alarm.

If the DP measurement goes above this threshold for more than 5 seconds --> no low DP alarm.

Note: if the low DP alarm is set to 000, it is inactive.

7) Cycle display:

Display of the time remaining (T2, T2A or T3) with menu LED flashing quickly opposite the corresponding time.

If manual or fan cycle in progress, the corresponding menu LED flashes quickly.

Number of current channel "nXX" displayed for one second for each pulse on a SV.

If DP = 1, "Max DP/Min DP" menu LED flashes rapidly

If high or low alarm reached, "High alarm/Low alarm" menu LED flashes rapidly.

If + button pressed, nxx displayed where xx = SV which will be operated for next blast.

If a fault is present, the fault type is displayed.

8) Stop type adjustment:

Select "Fcy" or "Sto".

"Fcy": to stop at end of cycle if linked to load loss.

"Sto": to stop cycle on current SV.

9) Number of output adjustment

Number of channels in the dust removal cycle

10) T1 adjustment:

Activation time of an output (in 1/100th of a second).

11) T2 adjustment:

Idle time between two outputs (in seconds).

12) T2A adjustment: if DP measurement sensor card incorporated

Idle time between two outputs (in seconds) if digital input "T2A" I1 closed.

13) T3 adjustment:

Idle time between two cycles (in minutes).

0: inactive.

14) T4 adjustment:

0: inactive.

Maximum non dust removal time (in hours).

If the sequencer has not performed a cycle for the number of hours set, the current cycle stops (if stopped on image) and a dust removal cycle is performed (the cycle remains linked to compressed air).

Note: timer T4 is initialised for every pulse on a SV.

15) Adjustment of the number of fan stopped cycles:

0: inactive.

If "Fan control" DIGITAL input I3 is lost, the current cycle ends and the configured number of cycles is performed.

Note: if input I3 reappears while the configured number of cycles is being performed, normal operation is restored.

Fan stopped can be detected by considering a load loss measurement below 20 daPa. Please contact us regarding choice of fan stopped detection.

16) Manual operation:

The current cycle ends and the set number of cycles is performed without taking into account links to compressed air, DP and fan operation.

17) Identifier number adjustment:

Identification number of the SF100 for an external connection (SF100 networked PC).

Note: The return to the "DP measurement display" occurs automatically after 30 seconds of inactivity (except in the "cycle display" position).

FAULT CHECK / DISPLAY

Faults are displayed:

in DP measurement display position (alternately with the measurement)
in cycle display position

Principle: faults are coded as follows:

Listed in order of priority on the display.

Note: faults are displayed in increasing SV number order.

Listed in order of priority on the display.

Note: faults are displayed in increasing SV number order.

1) "CFX" for initialisation configuration fault:

X represents an error code

- CF0: DP zero
- CF1: DP scale
- CF2: DPMAX threshold
- CF3: DPMIN threshold
- CF4: number of SVs
- CF5: time T1
- CF6: time T2
- CF7: DP low alarm threshold or DP high alarm threshold
- CF8: T2A time
- CF9:
- CFA: 4mA value of the 4-20ma output
- CFb: 20mA value of the 4-20ma output
- CFC:
- CFd:
- CFF: ID number

2) "DEF" for a passing electrical channel fault (short circuit)

Appears if current consumption has been detected on one of the outputs even though it is inactive.

4) "rXX" if no compressed air feedback fault

XX represents the number of the SV which generated the fault.

This check is performed if the "compressed air check" option is validated (factory set).

This fault appears after a blast, at the end of T2 if the compressed air input is 0.

Auto-resets if the next blast on this SV is OK.

5) "dAC for general compressed air fault

This check is performed if the "compressed air check" option is validated (factory set).

This fault appears if the compressed air input is open for more than 2 seconds outside a dust removal cycle

Auto-resets if the compressed air input is closed.

6) "cXX" for no compressed air consumption fault

This check is performed if the "compressed air check" option is validated (factory set).

XX represents the number of the SV which generated the fault.

A pressure consumption is considered to be correct if the compressed air input opens during SV activation or for the subsequent time T2.

If no compressed air consumption is detected 3 times in a row on the same SV, this fault appears.

Auto-resets if compressed air consumption is detected on this SV during the next cycle.

7) "dXX" for channel off electrical fault

Appears if no electrical power appears during activation of this SV.

XX represents the number of the SV which generated the fault.

Note: Channel 100 (SV100) is displayed as "00", i.e. n00 to operate channel 100 and d00 for fault on channel 100.

SIGNALLING ON THE FRONT PANEL

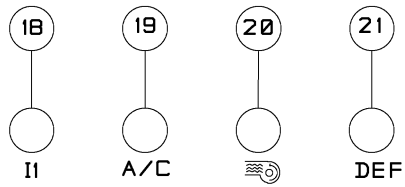

1) Led I1

Illuminated if DIGITAL input I1 closed. (t2a or DP running order if no DP measuring sensor card)

2) A/c (compressed air) LED

Illuminated if DIGITAL input I2 closed. (compressed air input)

3) Fan LED

Illuminated if DIGITAL input I3 closed. (fan control)

4) DEF (fault) LED:

Illuminated if a fault is present.

SIGNALLING ON THE MOTHER BOARD

Input I3 status
Input I2 status
Input I1 status

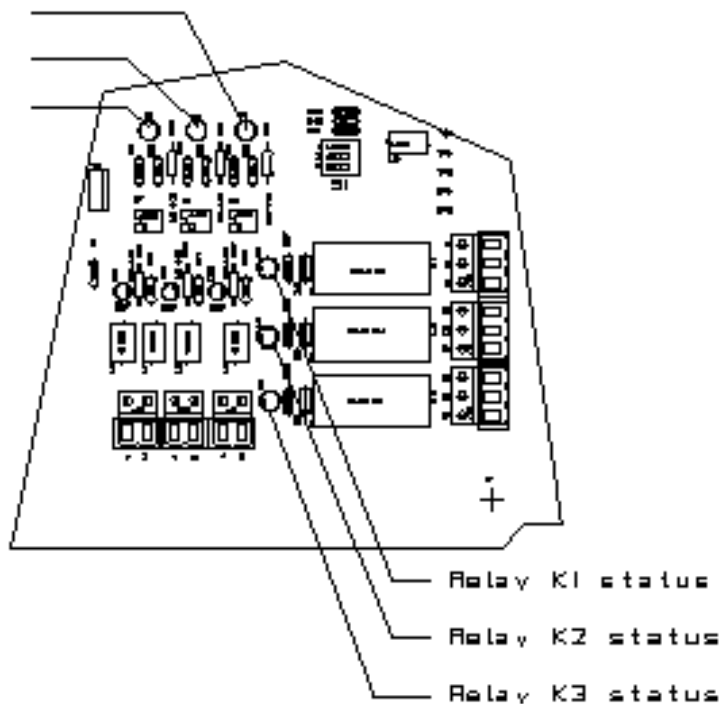

-

RELAY OUTPUTS

1) Relay K1: (any fault)

Relay energised if no fault

Relay cut off if fault present:

- passing channel electrical fault
- channel cut-off electrical fault
- compressed air fault (for compressed air check option)
- DP low alarm

2) Relay K2: (operating response)

Relay energised if sequencer in cycle and not in stop on image.

3) Relay K3: (DP high alarm)

Relay energised if no DP high alarm.

Relay cut-off for DP high alarm.

INPUTS

- I1 input: if no DP measurement, dust removal order is given on this input, otherwise this input becomes T2A. The input must be closed in order to perform dust removal cycles. T2A, dust removal with taking in account of T2A time if the input is closed. Otherwise T2 time is taken in account.

- I2 compressed air input: compressed air control is given on this input. The input must be closed to perform dust removal cycles.

- I3 input fan control: control of dust removal cycles. The input must be closed to perform dust removal cycles. When the input opens, the number of cycles set in function 15) is performed.

UNIT / SV PROTECTION

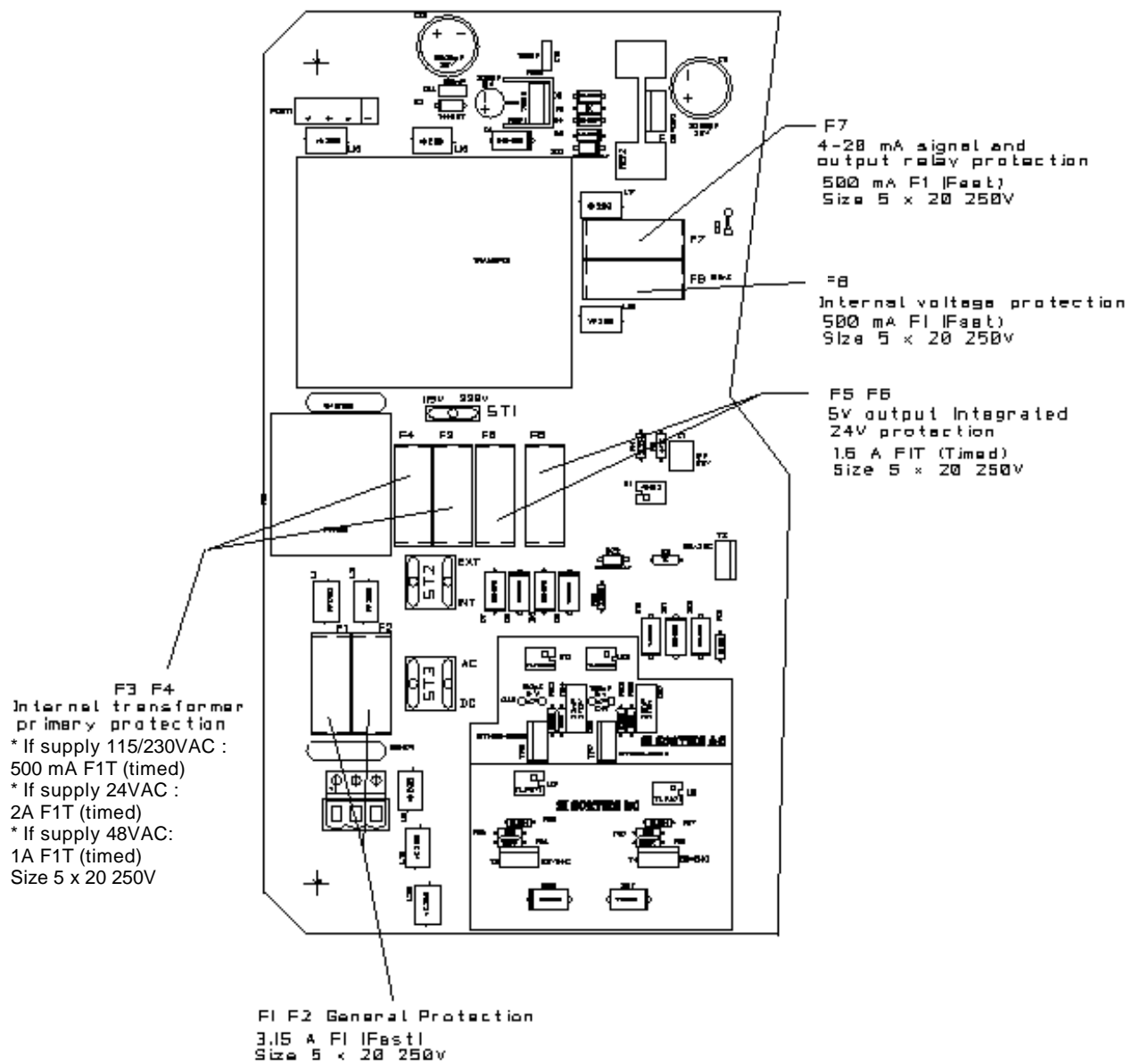

SUPPLY VOLTAGE ADJUSTMENT

Mains supply
115V 50/60Hz
or 24V AC

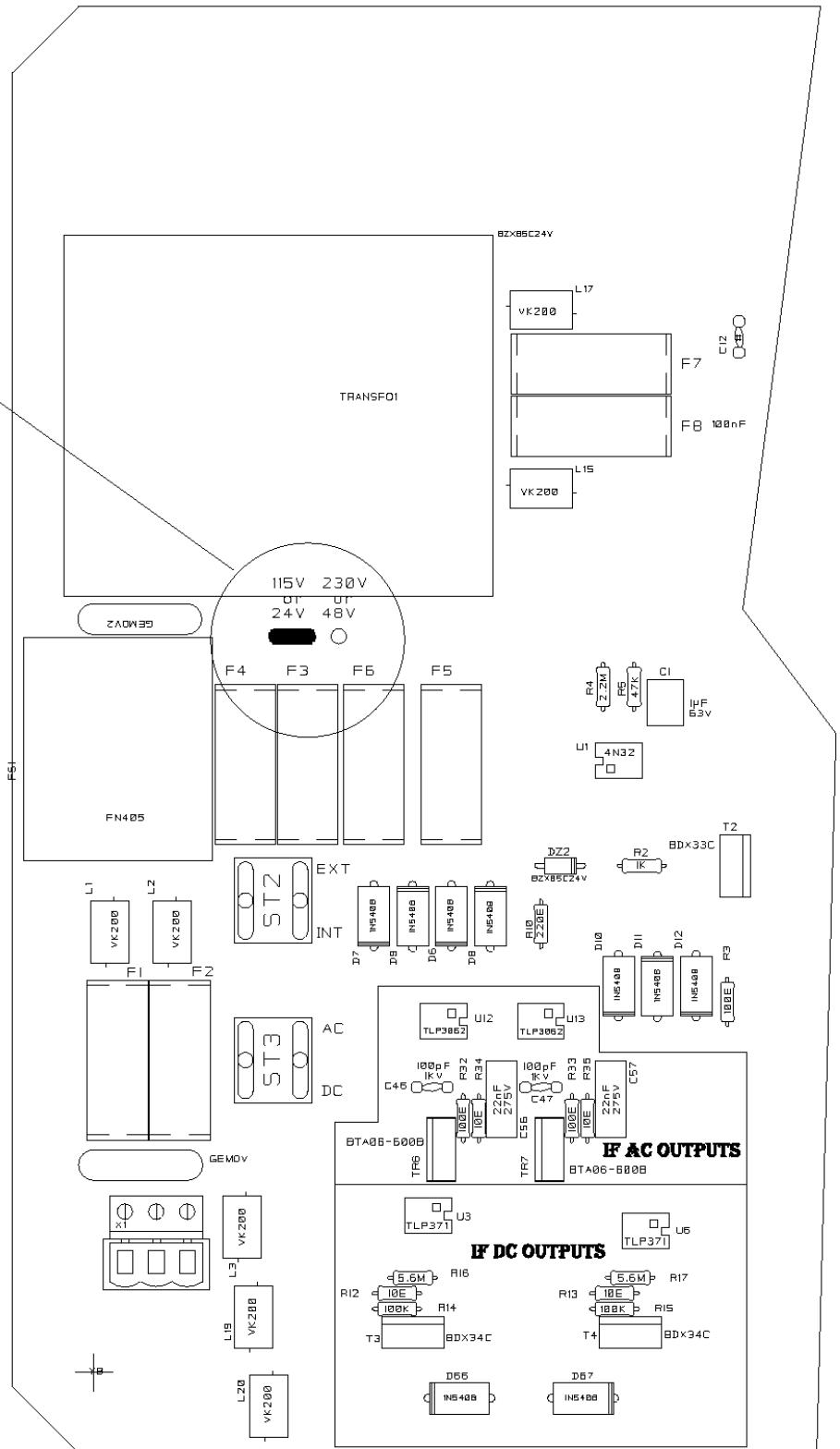

SV VOLTAGE ADJUSTMENT

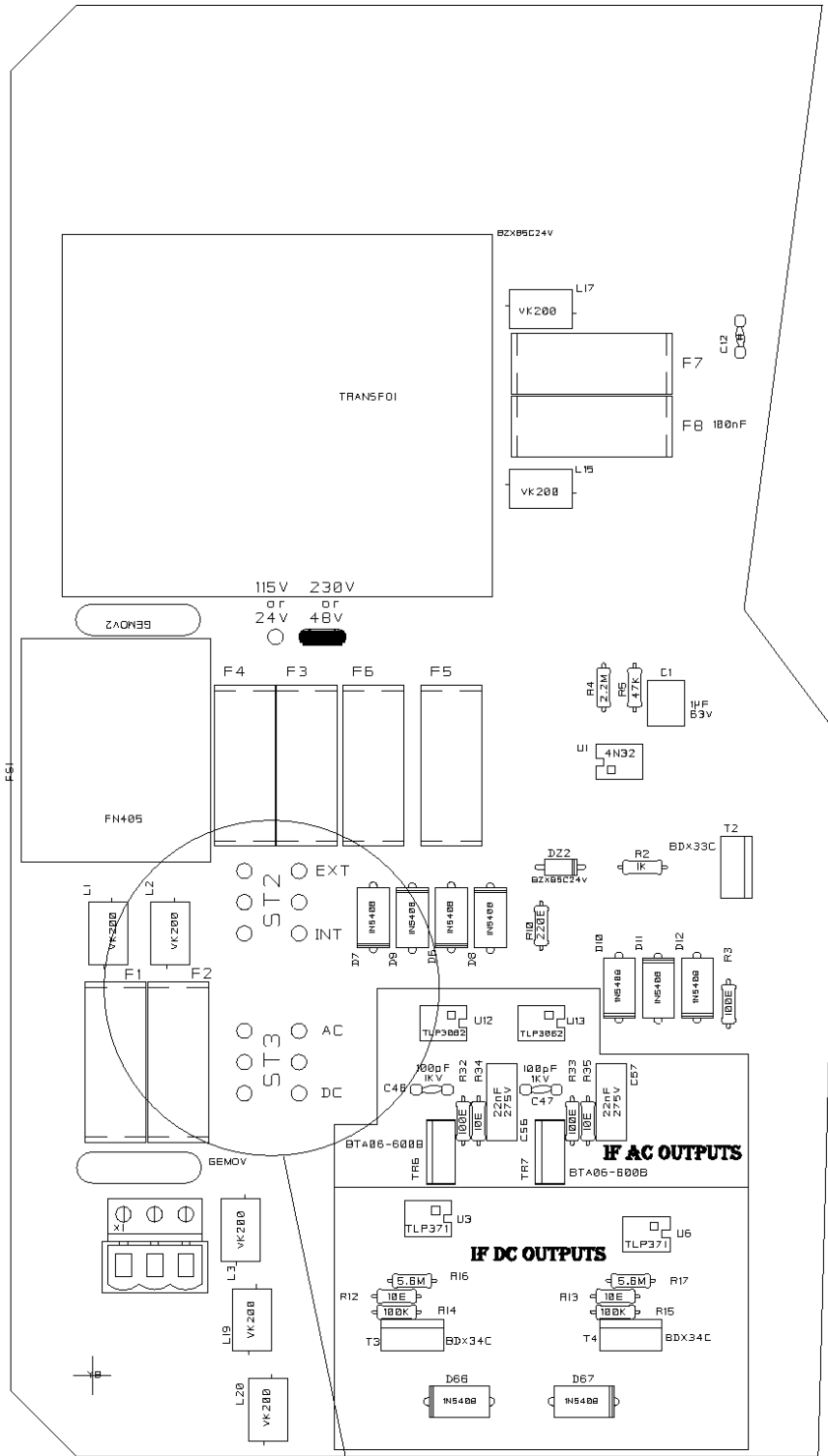

ST2 ST3 : Jumpers for adjustments
outputs voltage to 5V

Only jumpers ST2 can be adjusted by the user. On the 24VDC version, jumper ST2 must be positioned in INT.

SV output voltage depending on jumper position

SV voltage = Sequencer
supply voltage

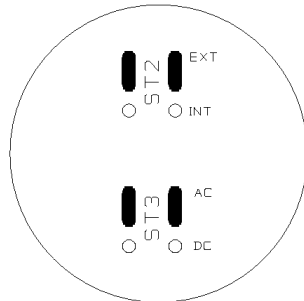

SV voltage = 24V 50/60Hz
internal

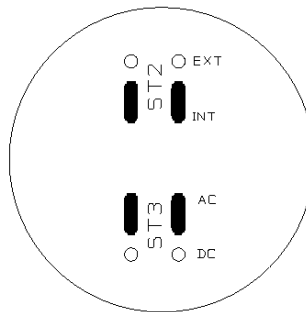

SV voltage = 24V DC
internal

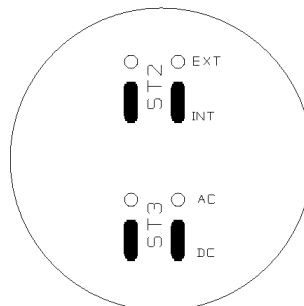

CONNECTIONS

Terminals and glands vary depending on the configuration of the SF100 unit.

Configuration is set when the product is ordered and forms part of the quotation for approval.

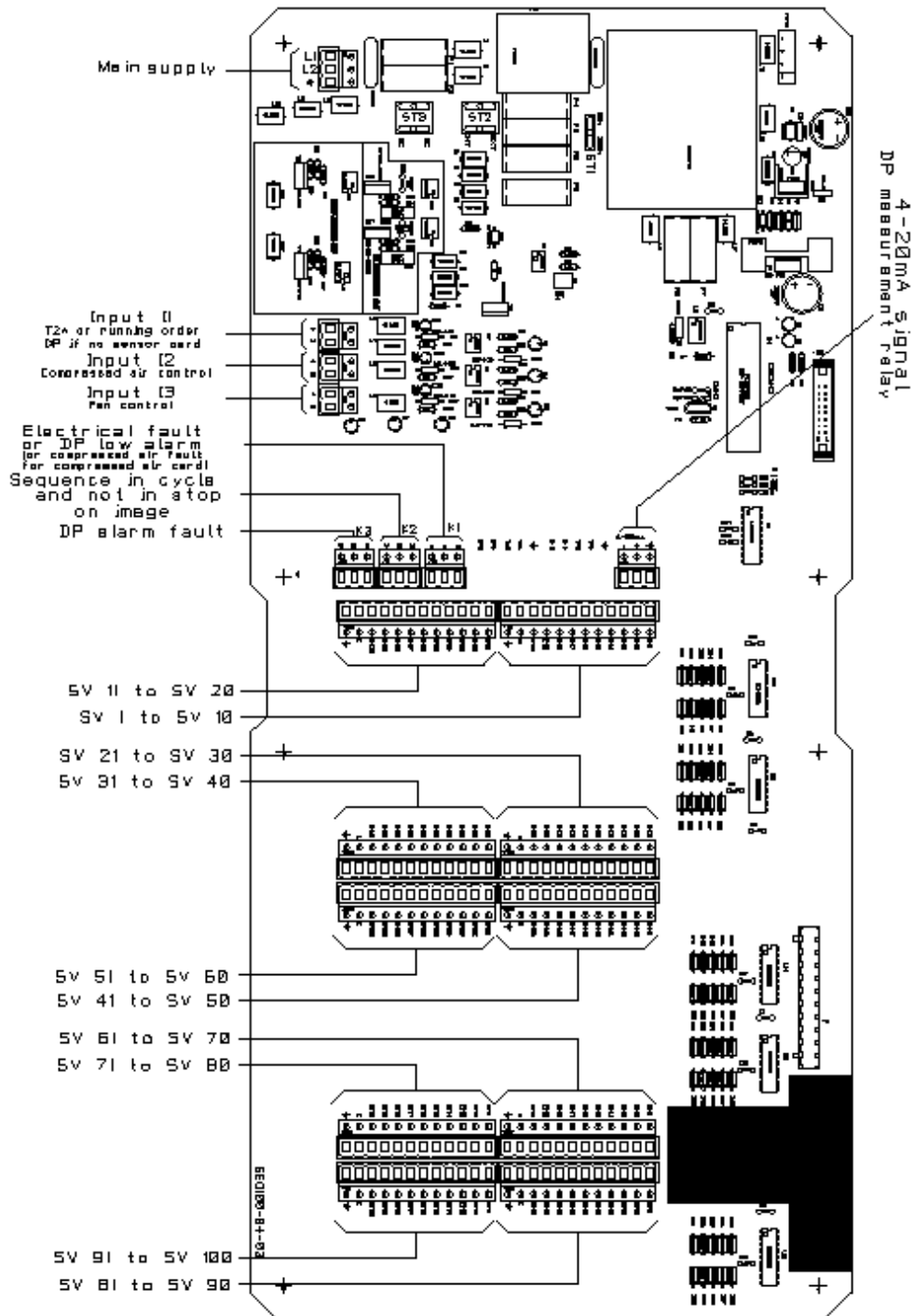

DIMENSIONS / MOUNTINGS

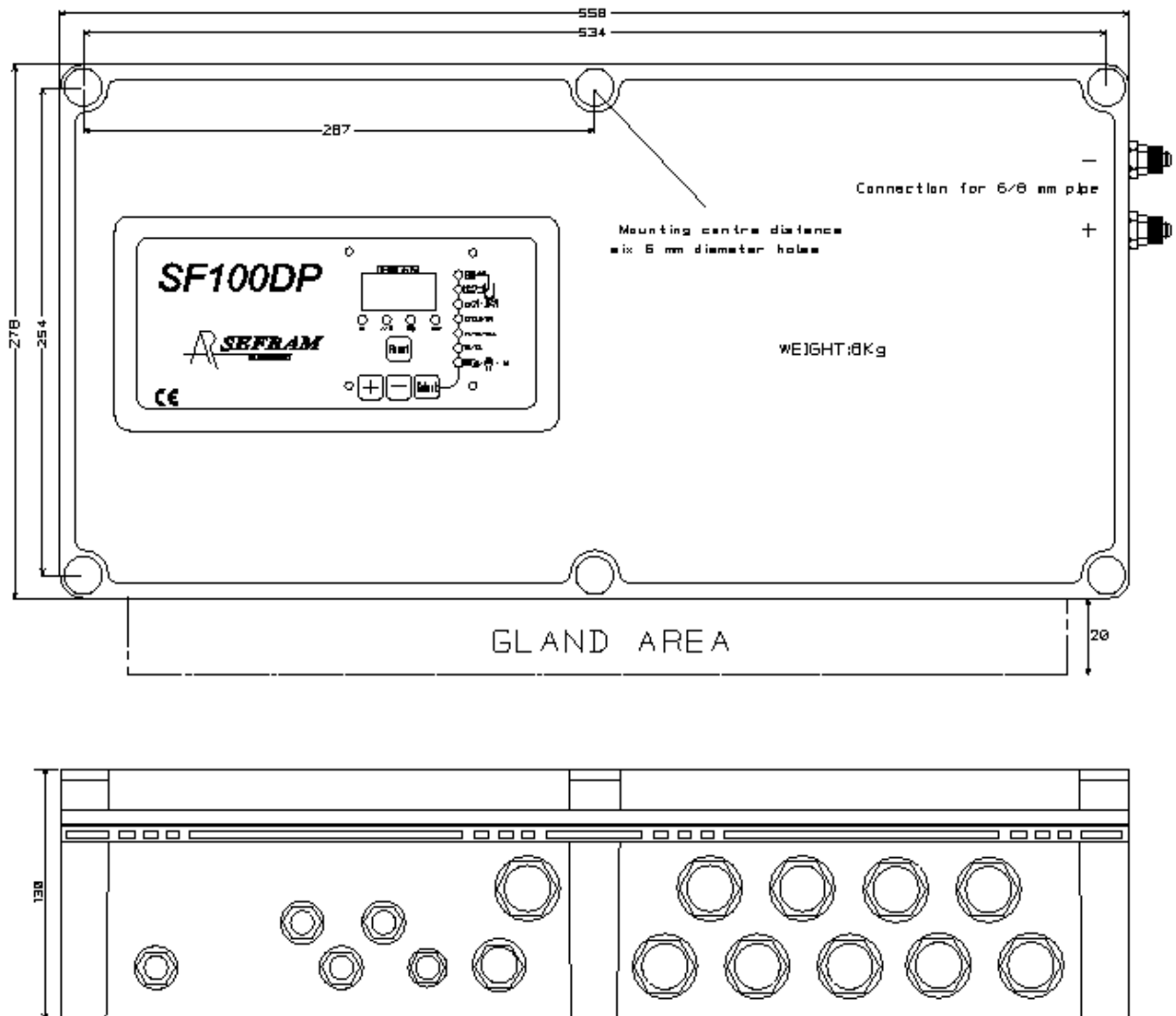

Gland configuration

1 x 11 mm gland for main power supply

3 x 11 mm glands for inputs

1 x 9 mm gland for 4-20 mA signal

1 x 16 mm gland for relay feedback signals

Depending on SF100DP configuration, 1 x 21 mm gland per 10 SVs

General instructions for safety, assembly, commissioning, usage and maintenance
to be read before working on the device

I. GENERAL

These instructions must be read jointly with:

+the standard NFC15-100

+the technical data sheet specific to the device

The Sefram devices are designed to be assembled, commissioned and used in compliance with the characteristics/data given in the technical data sheet. Always adhere to all of directives, legislation, orders and most recent standards in force for the stated field of application.

The assembly, commissioning, usage and maintenance operations must always be carried out by qualified and authorised personnel.

Personnel working on the devices must be familiar with the safety rules and requirements in force regarding the components, devices, machines and electrical installations.

II. RECEPTION - STORAGE

After unpacking the device, check that this latter has not been damaged during transport; for certain devices, remove the protective film from the cover. The material must be stored inside in a dry place.

In the event of a problem, please contact Sefram.

III. ASSEMBLY

The assembly operations must be carried out by qualified, skilled and authorised personnel. Personnel working on these devices must be familiar with the safety rules and requirements in force.

The box must be mounted vertically.

For material connected permanently to the network, a quickly accessible cut-off device must be incorporated into the cabling installation of the building.

The device supply must be equipped with a device for protection against risks of over-current and fault isolation. The number of poles protected must be appropriate to the neutral regime of the building and to the regulations in force.

The equipment must be connected to the PE protection mass by green/yellow wires (NFC15-100).

The device is compatible with the neutral regimes TT, TN or IT;

Nevertheless, we recommend that the device is supplied through the intermediary of an insulation transformer for which the primary is supplied between phases and not between phase and neutral, so as to avoid any accidental over-voltage caused when the neutral is cut before the phases.

In the event of a problem, please contact Sefram.

IV. COMMISSIONING AND USAGE

Commissioning is authorised only after duly establishing that the device, the machine or the installation in which the device has been integrated in a compliant manner, satisfies all of the directives, legislation, orders and most recent standards in force.

Commissioning operations must be carried out by qualified, skilled and authorised personnel. Personnel working on these devices must be familiar with the safety rules and requirements in force.

Note: correct operational functioning does not in itself constitute an indication of conformity to the recommendations for the use of the material in complete safety.

Also read the maintenance recommendations which equally apply during commissioning and use.

In the event of a problem, please contact Sefram

V. MAINTENANCE

The device does not require any special maintenance.

For devices equipped with the pressure measurement, in order to retain a precise pressure measurement, an annual calibration is advised particularly at « zero » (see § calibration on the technical data sheet)

The following operations are recommended; they constitute a minimum:

- Before any work intervention, we recommend that the dust is removed **before** opening the box,
- The device must not be opened in an excessively dusty environment,
- The settings must be carried out in the shortest lapse of time so as not to engender any risks,
- The integrity of the joints must be checked: remove any trace of dust or other deposit,
- Remove any trace of dust which could have penetrated during the setting operation,
- **Always** ensure that the transparent cover is correctly closed.

Maintenance operations must be carried out by qualified, skilled and authorised personnel. Personnel working on these devices must be familiar with the safety rules and requirements in force.

In the event of a problem or any questions during these operations please contact SEFRAM.

PRECAUTIONS:

- Avoid dusty air entering at the pressure taps.
- Take the necessary precautions to fit to the device characteristics/data (humidity, **maxi pressure**, etc.).
- For the 4-20mA cables, we recommend that you use shielded cable and do not follow the routing of the power cables.
- For special operating conditions : consult us
- Work interventions must always be carried out by duly qualified staff

CALIBRATION:

The device leaves our workshops, adjusted at 0, for zero pressure and at **maxi** for the **maxi pressure** value of the range.

Settings carried out when device stabilised and at 20° C.

It is possible to adjust the zero pressure:

- Put the device out-of-pressure (disconnect the pressure taps)
- Place it in the pressure reading mode (using « SELECT »)
- Activate the « - » key during more than one second
- Release the key « - »
- Before one second, activate « RESET » key during more than one second
- Then re-connect the pressure

WARRANTY:

The Warranty does not apply in the following cases:

- Breakage through dropping or knocks to non-packaged products
- Damage caused by abnormal use of the device, connecting error, surges/overvoltages, **overpressure**, etc.
- Any intervention on the device apart from the connections

In case of failure, no action is permitted and the unit must be returned to the following address:

**SEFRAM
PLACE GUTENBERG
59175 TEMPLEMARS
FRANCE**

CERTIFICATE:

The SF100DP respects the European directives (CEM and BT), which concerns it. However, it must be used correctly in applications for which it is intended, and should be linked or near CE approved products.

Certificate available on request.

We keep the right to make any modifications to our devices that we consider to be appropriate.