

**FEATURES**

- Field Bus data acquisition
- CAN open protocol
- Baud rate and ID Node programmable by dip-switch
- Configurable input for V and mA
- Four ways 2000 Vac galvanic isolation
- EMC compliance – CE Mark
- In compliance with EN-50022 DIN rail mounting

**GENERAL DESCRIPTION**

The device DAT 7015 is able to acquire up to 4 voltage signals up to  $\pm 10$  V or current signals up to  $\pm 20$  mA. The data are transmitted by the CANopen protocol.

By means of 16 bit converters, the device guarantees high accuracy and a stable measures both versus time and temperature.

The 2000 Vac galvanic isolation between inputs, power supply and data line eliminates the effects of all ground loops eventually existing and allows the use of the device in heavy environmental conditions found in industrial applications.

The DAT 7015 is in compliance with the Directive 2004/108/EC on the Electromagnetic Compatibility.

The DAT 7015 is housed in a rough self-extinguishing plastic enclosure of 22.5 mm thickness, suitable for DIN rail mounting in compliance with the EN 50022 standard .

**COMMUNICATION PROTOCOLS**

On the DAT7000 modules the following communication protocol is implemented:

**CANopen Protocol:** one of the most used standard communication protocol; it allows to interface the modules of DAT7000 series directly to the CAN Controllers that accept devices in compliance with the **CiA DS 301** and **CiA DS 401** standards. For communication setting, refer to the User manual.

**OPERATING INSTRUCTIONS**

Before to install the device, please read carefully the "Installation instructions" section.

Connect the power supply, the data line and the Input signals as shown in the "Wiring" section.

Refer to the "Led signalling" section to verify the correct working of the device.

To make easy the maintenance or the substitution of the device, it is possible the "hot swap" of the terminals.

**INSTALLATION INSTRUCTIONS**

The device DAT 7015 is suitable to be mounted on DIN rail, in vertical position.

For a correct working and a long life of the device, read the following indications.

**In case of the devices are mounted side by side, please leave about 5mm between in the following situations:**

- Temperature in the cabinet higher than 45 °C and high supply voltage ( >27Vdc ).

Avoid to place raceways or other objects which could obstruct the ventilation slits. It is suggested to avoid that devices are mounted above appliances generating heat; their ideal place should be in the lower part of the panel.

Avoid to install the devices in a site where vibrations are present.

It is recommended to use shielded cable for connecting signals. The shield must be connected to an earth wire provided for this purpose. Moreover it is suggested to avoid routing conductors near power signal cables.

**TECHNICAL SPECIFICATIONS (Typical @ 25 °C and under nominal conditions)**

Input type	Min	Max	Input Calibration	Sample time
<b>Voltage</b> Volt	- 10 V	+10 V	Volt $\pm 0.05$ % f.s. mA $\pm 0.05$ % f.s.	40 ms
<b>Current</b> mA	-20 mA	+20 mA	<b>Input impedance</b> Volt $\geq 1$ M $\Omega$ Current $\sim 22$ $\Omega$	<b>Data Transmission</b> Baud rate up to 1 Mbps Max. Distance in function of the Baud rate
			<b>Thermal drift</b> Full scale $\pm 0.01$ % / °C	<b>Warm-up time</b> 3 min.
				<b>Power Supply</b> Supply Voltage 10 .. 30 Vdc Current consumption 45 mA @ 24 Vdc Polarity inversion protection 60 Vdc max
				<b>Isolation Voltage</b> 2000 Vac 50 Hz, 1 min. (Inputs/Can Network/Power supply)
				<b>Temperature &amp; Humidity</b> Operating temperature -10°C .. +60°C Storage temperature -40°C .. +85°C Humidity (non condensing) 0 .. 90 %
				<b>Housing</b> Material Self-extinguishing plastic Mounting DIN rail in compliance with EN 50022 Weight $\sim 150$ g.
<b>Device profile</b>				<b>EMC ( for industrial environments )</b> Immunity EN 61000-6-2 Emission EN 61000-6-4
In compliance with the <b>CiA DS 301</b> and <b>CiA DS 401</b> standard.				

# WIRING

## INPUT WIRING

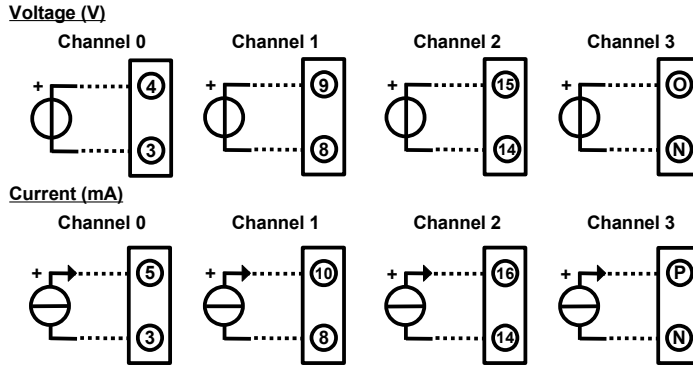

Terminals 3,8,14, and N = input negative reference

NOTES: the input channels are not insulated between them

### CAN NETWORK WIRING

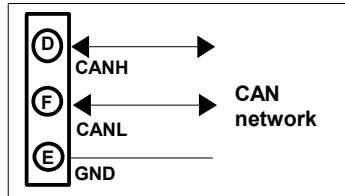

### POWER SUPPLY WIRING

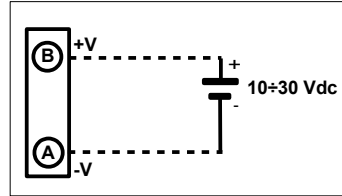

### DIP SWITCH POSITION

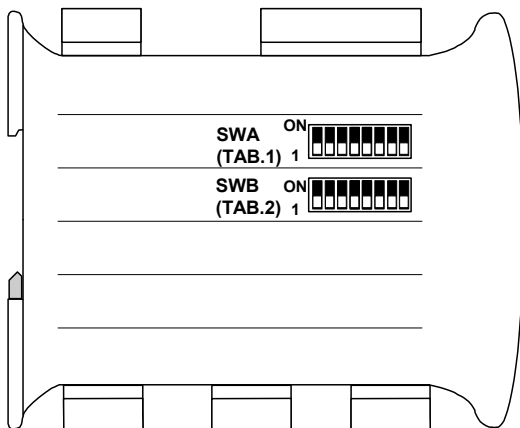

### DIP-SWITCH CONFIGURATION TABLES

TAB.1 Address setting 1-127  
(Pos.1 LSB; Pos.7 MSB)

SWA	1	2	3	4	5	6	7	Addr
1	0	0	0	0	0	0	0	Addr 1
1	0	0	0	0	0	0	1	Addr 2
1	0	0	0	0	0	1	0	Addr 3
1	0	0	0	0	1	0	0	Addr 4
1	0	0	0	1	0	0	0	Addr 5
1	0	0	1	0	0	0	0	...
1	0	1	0	0	0	0	0	...
1	1	0	0	0	0	0	0	Addr 127

TAB.2 Bit rate setting  
(Pos.5 LSB; Pos.8 MSB)

SWB	5	6	7	8	Bit rate
0	0	0	0	0	10 Kbps
0	0	0	1	0	20 Kbps
0	0	1	0	0	50 Kbps
0	0	1	1	0	125 Kbps
0	1	0	0	0	250 Kbps
0	1	0	1	0	500 Kbps
0	1	1	0	0	800 Kbps
0	1	1	1	0	1 Mbps

## CABLING

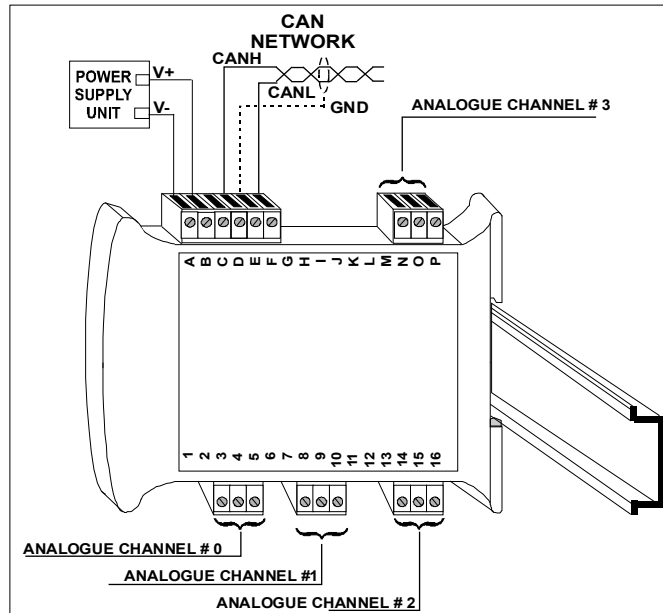

## ISOLATION STRUCTURE

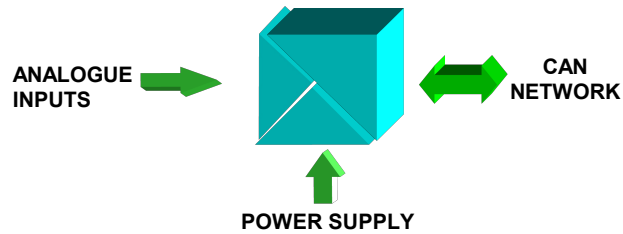

## MECHANICAL DIMENSIONS (mm)

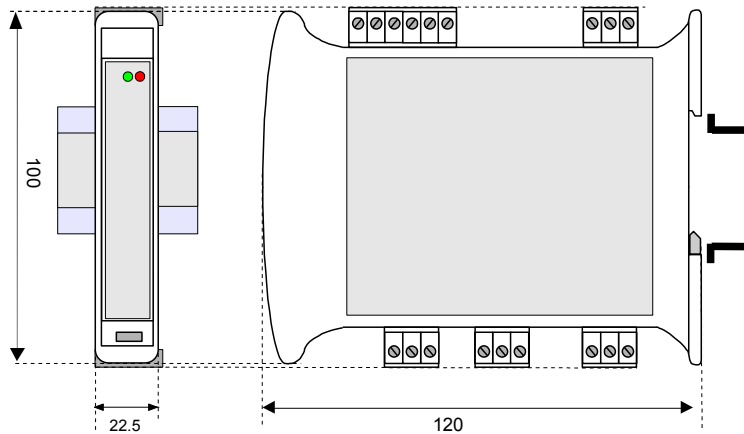

## LED SIGNALLING

LED	COLOR	STATE	DESCRIPTION
RUN	GREEN	ON	Device in Operational mode
		BLINKING	Device in Pre-Operational mode
		SLOW BLINKING	Device stopped
ERR	RED	OFF	No error
		ON	Bus off
		BLINKING	Invalid configuration

**HOW TO ORDER**  
DAT 7015