

MD-45 AC
MD-45 LV/HV

INSTALLATIONSANVISNING INSTALLATION MANUAL INSTALLATIONS ANLEITUNG MANUEL D'INSTALLATION

6157-2003

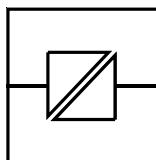

Galvanic
Isolation

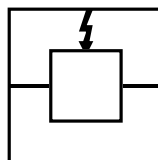

Transient
Protection

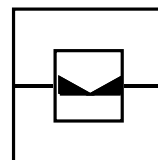

Balanced
Transmission

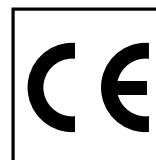

CE
Approved

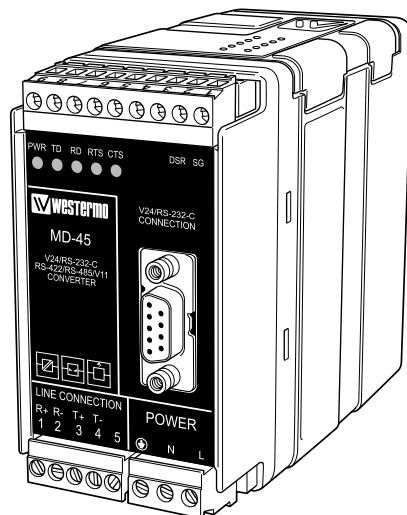

*Omvandlare RS-232 – RS-422/485
Converter RS-232 – RS-422/485
RS-232 – RS-422/485 Wandler
Convertisseur RS-232-RS-422/485*

[®]
WESTERMO

 **westermo**[®]
www.westermo.com

Contents

1. Introduction	17
2. Safety	18
3. Approvals	18
3.1 Declaration of conformity	19
4. Specifications	20
4.1 Interfaces	20
4.2 Insulation between interfaces	20
4.3 Climatic environment	21
4.4 Mechanics	21
5. Maintenance	21
6. Installation	22
6.1 Mounting /Removal	22
6.2 Connections	23
6.2.1 LED indicators	23
6.2.2 Power (MD-45 HV, AC)	24
6.2.3 Power (MD-45 LV)	24
6.2.4 Line connection (RS-422/485)	24
6.2.5 Terminal connection (RS-232, DCE)	24
6.3 Configuration	25
6.3.1 DIP switch settings	25–26
7. Functional description	27
7.1 Block diagram	27
7.2 2 Line connection	27
7.3 Hints	28

1. Intruduction

The MD-45 is used to convert between RS-422/485 and RS-232/V.24 signals. This device is often used in multidrop applications connected to a PC or PLC.

In 2-wire half duplex applications (RS-485) the direction of the bus can be controlled by data which means that the converter turns the bus depending on the data sent on the bus. This makes it possible to use the unit with equipment that has no handshaking signals. The maximum transmission rate possible is 115.2 kbit/s.

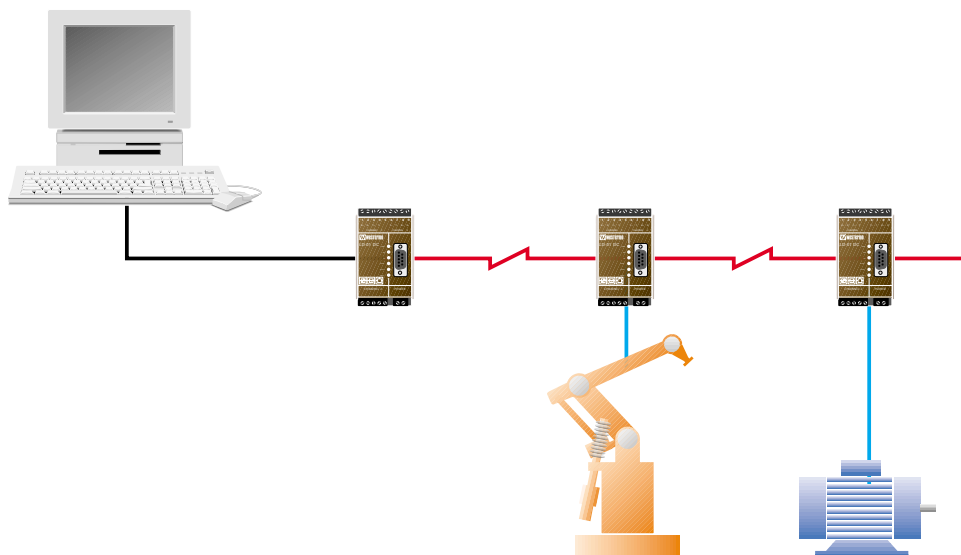

2. Safety



General:

Before using this unit, read this manual completely and gather all information on the unit. Make sure that you understand it fully. Check that your application does not exceed the safe operating specifications for this unit.



Before installation, maintenance or modification work:

Prevent damage to internal electronics from electrostatic discharges (ESD) by discharging your body to a grounding point (e.g. use of wrist strap).

Prevent access to hazardous voltages by disconnecting the unit from AC/DC mains supply and all other electrical connections.



Installation:

This unit should only be installed by qualified personnel.

This unit should only be installed in a "restricted access area", for example a lockable cabinet where access is restricted to service personnel only.

This unit is intended for permanent connection to the AC/DC mains supply.

The power supply wiring must be sufficiently fused, and if necessary it must be possible to disconnect manually from the AC/DC mains supply. Ensure compliance to national installation regulations.

Unit with the rated voltage exceeding 42.4 V peak or 60 VDC, is defined as class I equipment with a protective earthing conductor terminal.

Unit with the rated voltage up to 42.4 V peak or 60 VDC, is defined as class III equipment and shall be separated from hazardous voltage by double or reinforced insulation.

This unit uses convection cooling. To avoid obstructing the air flow around the unit, follow the spacing recommendations (see under chapter Installation).

3. Approvals

Conformity with the Directive 73/23/EEC (Low Voltage Directive) has been assessed by application of the standard EN 60 950.

Conformity with the Directive 89/339/EEC (Electromagnetic compatibility) has been assessed by application of standards EN 61000-6-2 (industrial immunity) and EN 61000-6-3 (residential emission).

3.1 Declaration of conformity

Westermo Teleindustri AB

Declaration of conformity

The Westermo Teleindustri AB company declares that the listed products conforms to the Council Directive 89/336/EEC, related to Electro Magnetic Compability and 72/23/EEC Low Voltage Directive.

Type of equipment: DIN-rail converter RS232-RS422/485
Model: MD-45 AC 3157-0101, 3157-0110
MD-45 HV 3157-1101
MD-45 LV 3157-0001

Standards:

EMC: EN 61000-6-3/CISPR22(EN 55022): Class B
EN 61000-6-2/EN 61000-4-2
EN 61000-6-2/EN 61000-4-3
EN 61000-6-2/EN 61000-4-4
EN 61000-6-2/EN 61000-4-5
EN 61000-6-2/EN 61000-4-6
EN 61000-6-2/EN 61000-4-11
EN 61000-6-2/EN 61000-4-16
Safety: EN 60950

Reference: Installation manual MD-45 AC/HV,LV Art. Nr. 6157-2003



Hans Levin
Technical Manager
May 2003

Postadress/Postal address	Tel.	Telefax	Postgiro	Bankgiro	Org.nr/ Corp. identity number	Stäte/ Registered office
S-640 40 Stora Sundby Sweden	016 - 42 80 00 Int +46 16 42 80 00	016 ñ 42 80 01 Int +46 16 42 80 01	52 72 79-4	5671-5550	556361-2604	Eskilstuna

4. Specifications

4.1 Interfaces

Power

Model description	MD-45 AC	MD-45 LV	MD-45 HV
Rated voltage	230 VAC	12–30 VAC 12–48 VDC	95–240 VAC 110–250 VDC
Operating voltage	207–253 VAC	10–45 VAC 9,6–60 VDC	85.5–264 VAC 88–300 VDC
Rated current	22 mA	300 mA	25 mA @ 240 V, 50 mA @ 95 V
Rated frequency	48–62 Hz	48–62 Hz	48–62 Hz
Polarity	PE, L and N	Independent	PE, L and N
Connection	3-pos screw block	2-pos screw block	3-pos screw block
Connector size	0.2 – 2.5 mm ² (AWG 24-12)		
Fuse	To be externally fused		

RS-485/422

Electrical specification	RS-422/485
Data rate	1 200 – 115 200 bit/s
Connection	5-pos screw block
Connector size	0.2 – 2.5 mm ² (AWG 24-12)
Circuit type	TNV-1

RS-232

Electrical specification	RS-232-C
Data rate	1 200 – 115 200 bit/s
Connection	9-pos D-sub, DCE
Circuit type	SELV

4.2 Insulation between interfaces

Power (MD-45 HV and AC) to all other	3.0 kV RMS @ 50 Hz and 60 s duration
Power (MD-45 LV) to all other	1.0 kV RMS @ 50 Hz and 60 s duration
RS-232 to RS-485/422	1.0 kV RMS @ 50 Hz and 60 s duration

4.3 Climatic environment

Temperature, operating	5 to 55°C
Temperature, storage and transportation	-25 to 70°C
Relative humidity, operating	5 to 95% (non-condensing)
Relative humidity, storage and transportation	5 to 95% (condensation allowed outside packaging)

4.4 Mechanics

Dimension (W x H x D)	55 x 100 x 128 mm
Weight	0.5 kg AC, 0.25 kg HV and LV
Mounting	35 mm DIN-rail
Degree of protection	IP 20 (IEC 529)

5. Maintenance

No maintenance is required, as long as the unit is used as intended within the specified conditions.

6. Installation

6.1 Mounting /Removal



Before mounting or removing the unit:

Prevent damage to internal electronics from electrostatic discharges (ESD) by discharging your body to a grounding point (e.g. use of wrist strap).

Prevent access to hazardous voltages by disconnecting the unit from AC/DC mains supply and all other electrical connections.

Mounting

This unit should be mounted on 35 mm DIN-rail which is horizontally mounted on a wall or cabinet backplate.

This unit uses convection cooling. To avoid obstructing the air flow around the unit, use the following spacing rules.

Minimum spacing 25 mm (1.0 inch) above/below and 10 mm (0.4 inches) left/right the unit.

Snap on mounting, see figure.

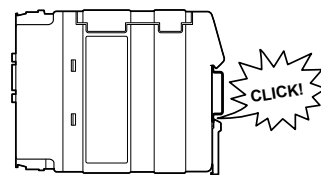
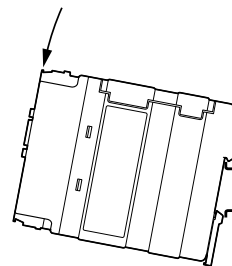
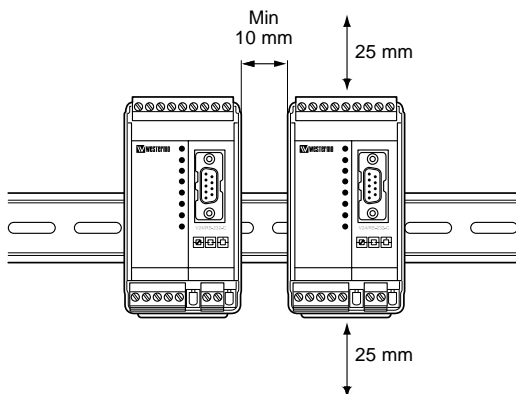

Removal

Press down the black support at the back of the unit using a screwdriver, see figure.

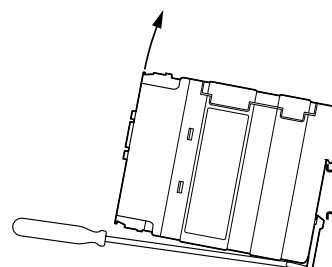
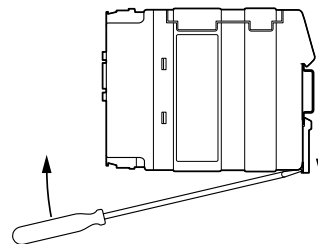

6.2 Connections

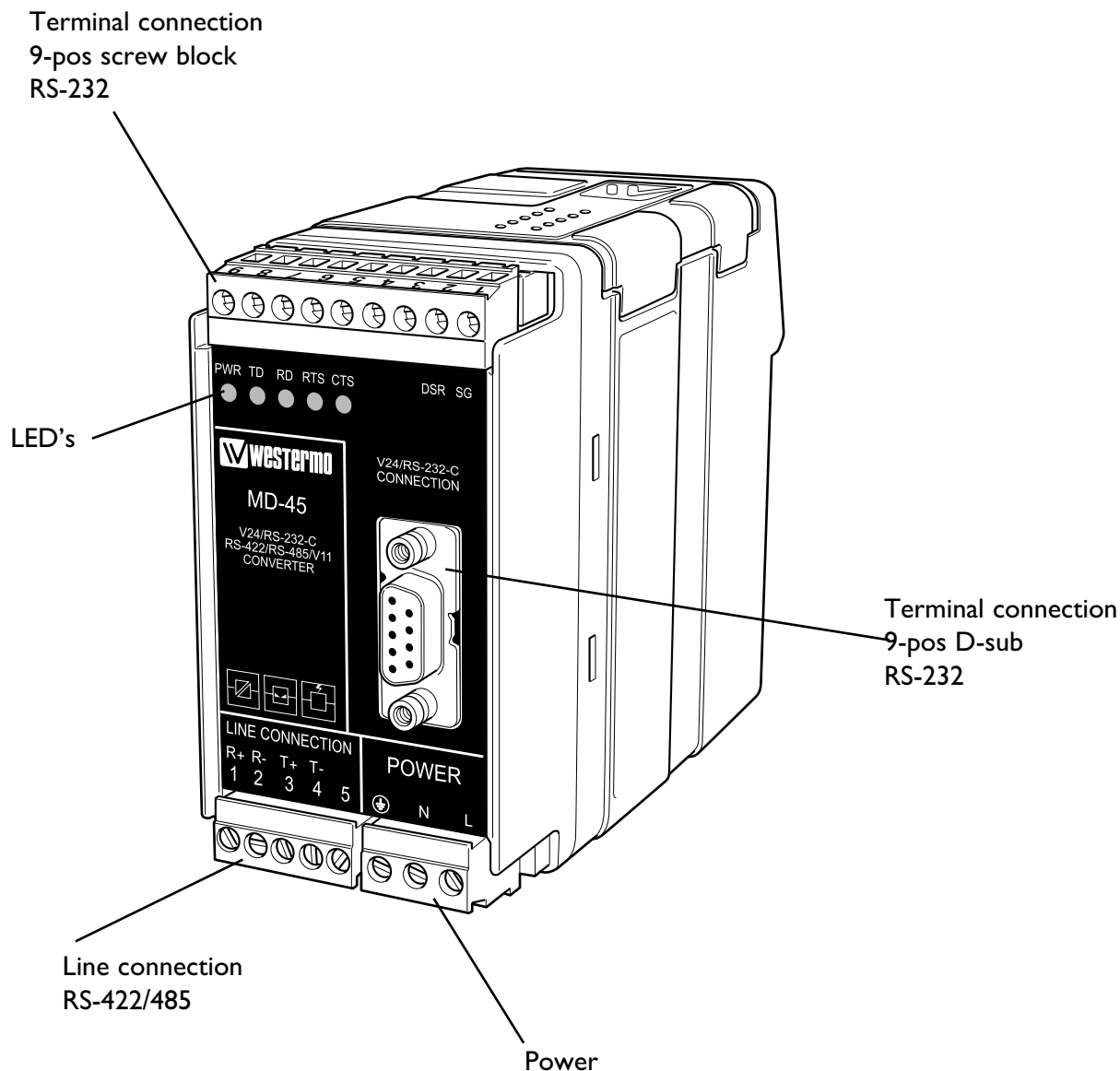

6.2.1 LED indicators

PWR	Power Indication
RTS	Request To Send modem signal
TD	Transmitted Data: Displays data received from the local RS-232/422/485 port
RD	Received Data: Displays data leaving the modem on the RS-232/422/485 port
CTS	Clear To Send modem signal

6.2.2 Power (MD-45 HV, AC)

3-pos screw terminal	Description
L	Line
N	Neutral
	Protective earth



6.2.3 Power (MD-45 LV)

2-position screw terminal	Description
No. 1	-Voltage
No. 2	+Voltage



6.2.4 Line connection (RS-422/485)

5-position screw terminal	Direction	Description
No. 1	In	A' (R+)
No. 2	In	B' (R-)
No. 3	In/Out	A (T+)
No. 4	In/Out	B (T-)
No. 5	-	Shield



6.2.5 Terminal connection (RS-232, DCE)

Screw terminal	9-pos D-sub	Direction	Description
7	2	Out	Receive Data (RD)
8	3	In	Transmit Data (TD)
1 & 9	5	-	Signal ground (SG)
2	6	Out	Data set ready (DSR)
6	7	In	Request to send (RTS)
5	8	Out	Clear to send (CTS)

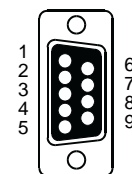
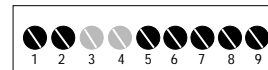

Screw terminal 3 and 4 not used

6.3 Configuration

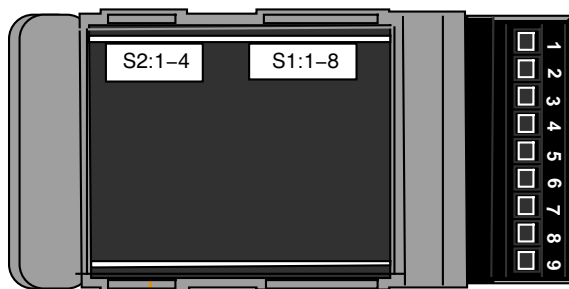

6.3.1 DIP-switch settings

DIP-switches are accessible under the lid on top of the unit. DIP-switches are used to configure the modem.



Warning!

Prevent damage to internal electronics from electrostatic discharges (ESD) by discharging your body to a grounding point (e.g. use of wrist strap), before the lid on top of the modem is removed.







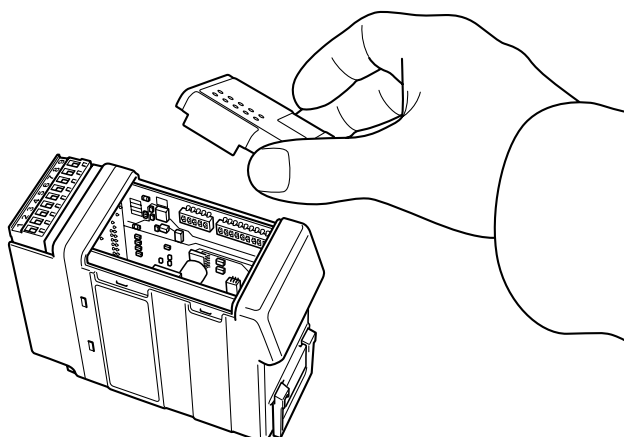



Warning! Do not open connected equipment.



Prevent access to hazardous voltages by disconnecting the unit from AC/DC mains supply and all other electrical connections.



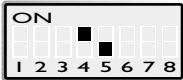

Selection of data rate

	Data rate	Turning time
SI 	1 200	780 μs
SI 	2 400	410 μs
SI 	4 800	220 μs
SI 	9 600	130 μs
SI 	19 200	48 μs
SI 	38 400	34 μs
SI 	57 600	22 μs
SI 	115 200	11 μs

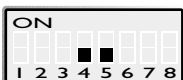

Selection of bits

SI 	9
SI 	10
SI 	11
SI 	12



2/4-wire transmission

SI 	2-wire
SI 	4-wire

Data or RTS-control



SI 	Data control
SI 	RTS-control
SI 	Transmitter always active

Termination with fail-safe *

S2 	Terminated (4-wire)
S2 	Terminated (2-wire)
S2 	No termination

* The fail-safe function forces the signal state of the receiver to OFF when the connected transmitter is in tri-state (transmitter inactive). The receiver located furthest away shall be terminated.

Factory settings

SI 
S2 
SI: 8 not used

Supervision table when selecting data bits

7 bits	●	●	●		●		
8 bits				●		●	●
No parity	●	●		●		●	
Parity			●		●		●
1 stop bit	●		●	●			●
2 stop bits		●			●	●	
Number of bits	9	10	10	10	11	11	12

7.0 Functional description

When the converter is set to data-control mode the transmitter is activated by data on TD (RS-232). The time the transmitter stays active corresponds to one character-time and turning time for the set data rate and number of bits. If there is more data on TD before the turning time is ended the transmitter stays active for additional one character. In RTS-control mode the transmitter is activated by the RTS-signal. In this mode the switches for data rate and number of bits has no effect. The LED indicators is controlled by the data signals. The active termination secures that the signal level at the receiver is in off-state (>0.2 Volts) when there is no data transmission. Full duplex is only possible if RS-422 is used.

7.1 Block diagram

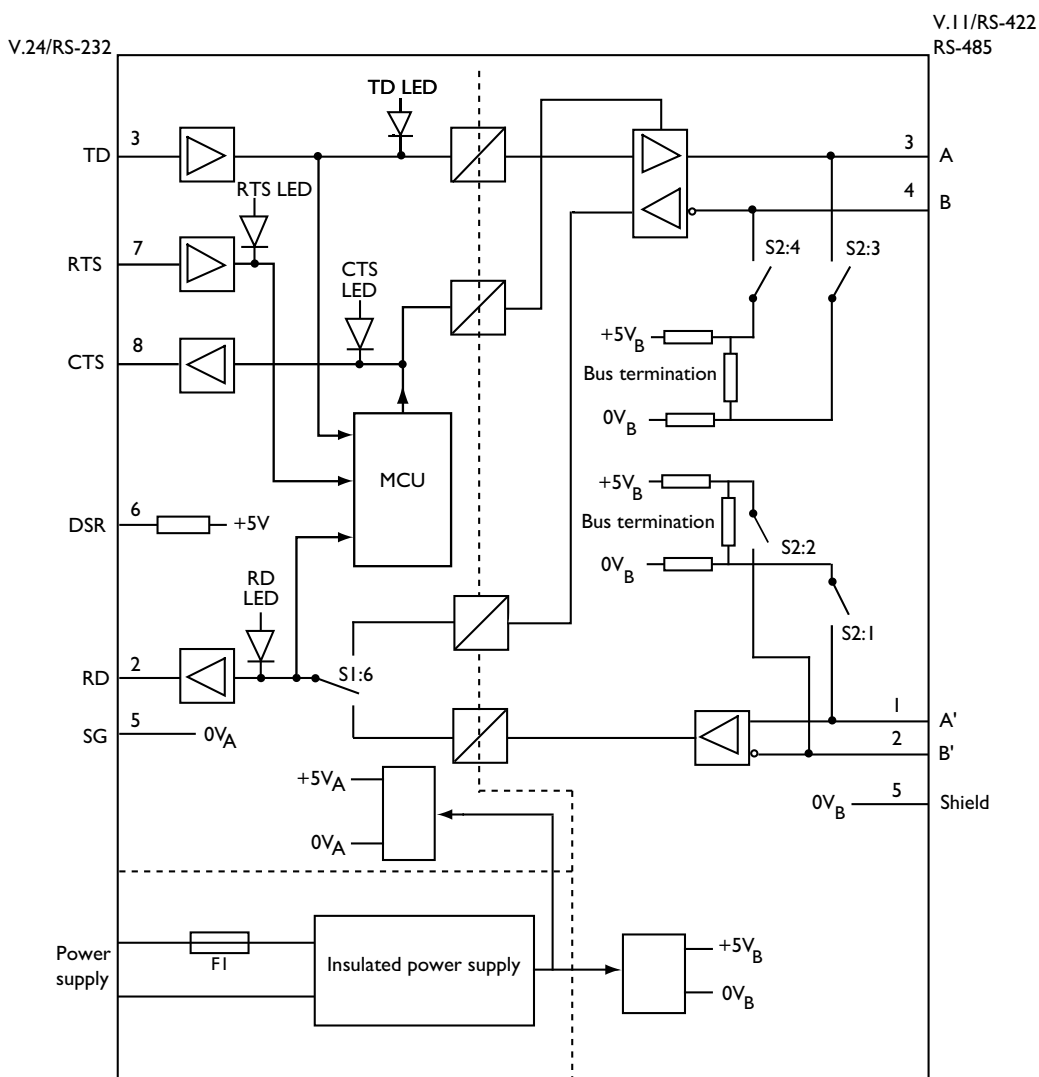

7.2 Line connection

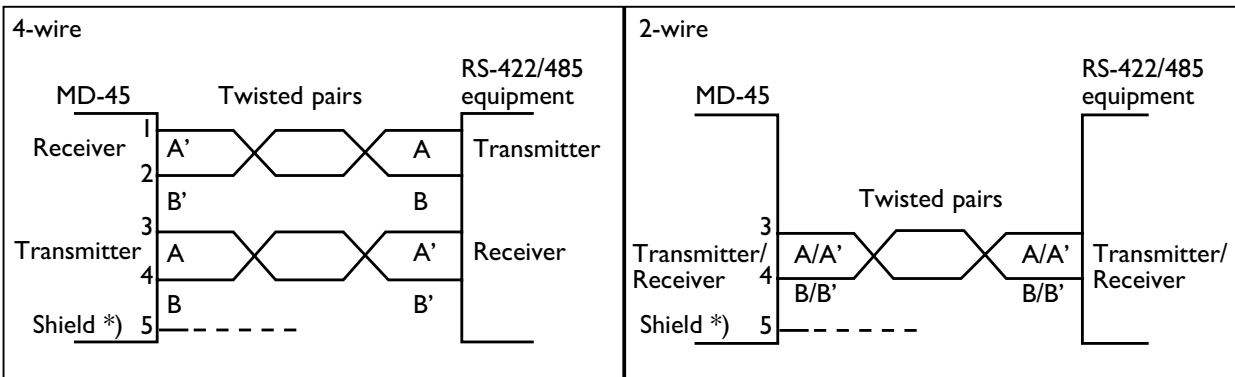

*) If shielded cable is used, connect the shield only at one end to avoid ground currents.

7.3 Hints

RS-422/485 was designed for multidrop applications. When a system is installed it should form a bus structure (see diagrams). Star shaped networks should never be created, there are other Westermo products designed to work in star net applications. To get a correct installation according to the RS-422/485 specification it's very important that the line is terminated at the correct points. The recommendation is to terminate the receiver on the master unit and the final bus slave unit. See diagrams for details of how this is done with RS-485 (2-wire) and RS-422 (4-wire).

The line transmitter used in the MD-45 is activated by data received on the RS-232 interface, unlike conventional converters that rely on a control signal (e.g. RTS).

If any problems do occur on set up of the MD-45, the LED's will be helpful.

- PWR: The unit has power.
- RD: Data received on the RS-422/485 interface.
- CTS: Follows RTS.
- RTS: Status of RTS from the RS-232 interface.
- TD: Data received on RS-232 interface.

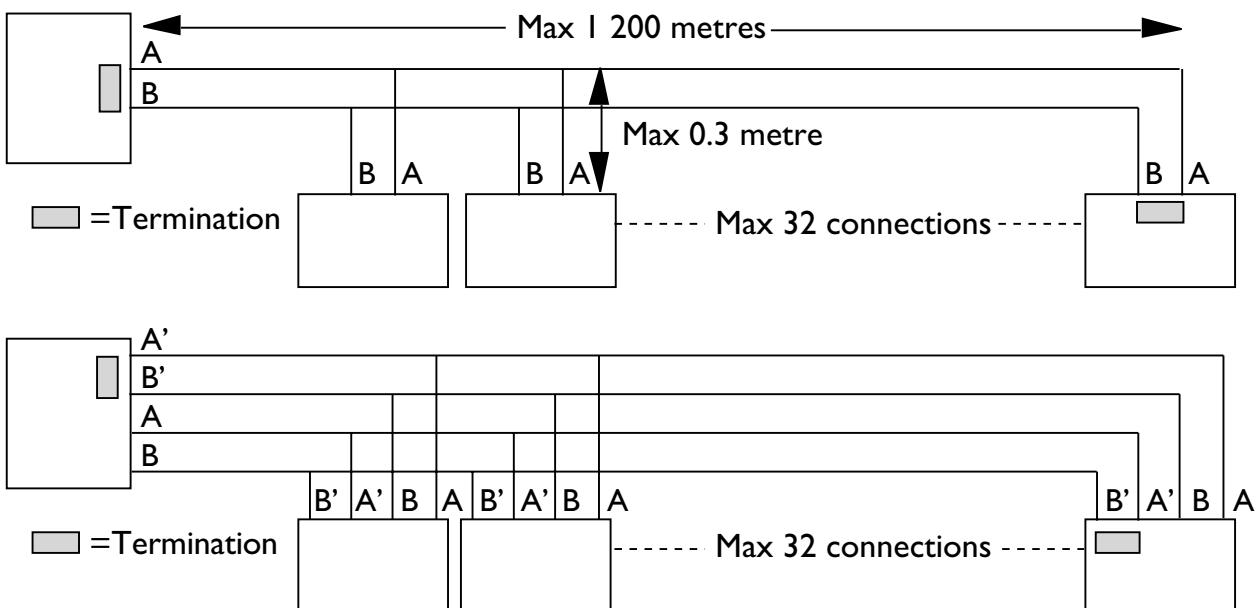

N.B. R+/R-, T+/T- definitions are not standard, it can help to shift A and B if the unit does not work.

Application examples

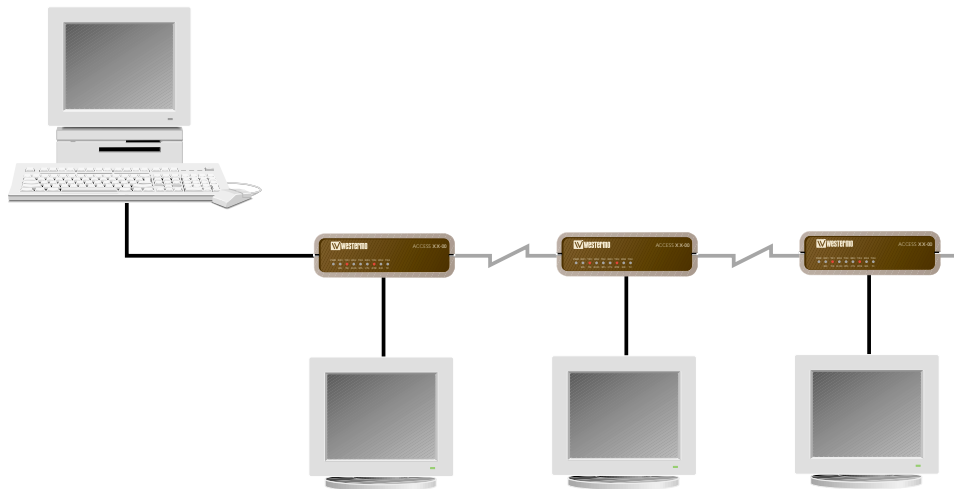

Westermo Teleindustri AB • SE-640 40 Stora Sundby, Sweden

Phone +46 16 42 80 00 Fax +46 16 42 80 01

E-mail: info@westermo.se

Westermo Web site: www.westermo.com

Subsidiaries

Westermo Data Communications Ltd
Unit 14 Talisman Business Centre • Duncan Road
Park Gate, Southampton • SO31 7GA
Phone: +44(0)1489 580 585 • Fax.:+44(0)1489 580586
E-Mail: sales@westermo.co.uk

Westermo Data Communications GmbH
Goethestraße 67, 68753 Waghäusel
Tel.: +49(0)7254-95400-0 • Fax.:+49(0)7254-95400-9
E-Mail: info@westermo.de

Westermo Data Communications S.A.R.L.
9 Chemin de Chilly 91160 CHAMPLAN
Tél : +33 1 69 10 21 00 • Fax : +33 1 69 10 21 01
E-mail : infos@westermo.fr

Westermo Teleindustri AB have distributors in several countries, contact us for further information.