

TL50YRQ

LED Indicator – Tower Light

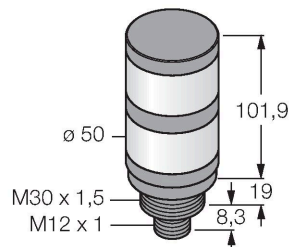

Technical data

Type	TL50YRQ
ID	3010341
Signal and display data	
Purpose	LED indicator light
Function	Tower light
Light type	Yellow Red
Dimmable	no
Features of color 1	Yellow, Permanently on, 5 lm
Features of color 2	Red, Permanently on, 7.5 lm
Electrical data	
Operating voltage	18...30 VDC
DC rated operational current	≤ 45 mA
Operating voltage	21...27 VAC
AC rated operational current	≤ 45 mA
Max. current consumption per color	45 mA
Input type	Bipolar (PNP/NPN)
Response time typical	< 10 ms
Mechanical data	
Cascadable	No
Design	Smooth barrel, TL50
Dimensions	Ø 50 x 129.2 x 129.2 mm
Housing material	Plastic, ABS, Black
Window material	Polycarbonate, diffuse
Electrical connection	Connector, M12 × 1, PVC
Number of cores	4
Ambient temperature	-40...+50 °C

Features

- Plastic housing, black
- EMI and RFI immune
- Protection class IP67
- M12 × 1 male connector
- Multicolor: Yellow (COL 1) / Red (COL 2)
- Operating voltage: 18...30 VDC or 24 VAC with 45 mA per LED color
- Inputs: PNP/NPN

Wiring diagram

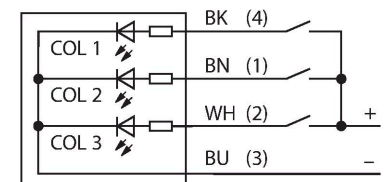

Functional principle

The TL50 tower lights provide highly visible status indicators and a clear user guidance within the entire system. They can be assembled from varicolored LEDs and are available with or without beeper. You can mount them directly on machines, in the cabinet or in monitoring locations of production lines.

The wiring diagram shows a PNP pin assignment.

There are 10 colors available blue (B), green (G), red (R), yellow (Y), white (W), turquoise (T), orange (O), violet (V), sky blue (S) and magenta (M), which specify the light sequence from bottom to top in the type code of the tower light. Example: TL50GYRQ, colors green, yellow and red arranged from bottom to top.

Technical data

Relative humidity	0...95 %
Protection class	IP67
Tests/approvals	
Approvals	CE, UL listed

Accessories

SMB30A 3032723

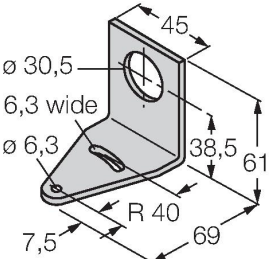

Mounting bracket, rectangular, stainless steel, for sensors with 30mm thread

Dimensions: 45, 6.3 wide, 6.3, 38.5, 61, 69, 7.5, R 40, 30.5, 6.3

SMB30FA 3074005

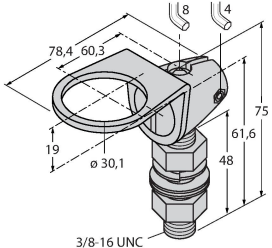

Montagewinkel; Werkstoff VA 1.4401

Dimensions: 78.4, 60.3, 19, 30.1, 75, 61.6, 48, 3/8-16 UNC, 8, 4

SMB30SC 3052521

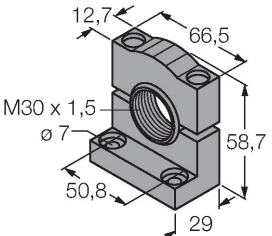

Mounting bracket, PBT black, for sensors with 30 mm thread, rotatable

Dimensions: 12.7, 66.5, 58.7, 29, 50.8, 7, M30 x 1.5

Accessories

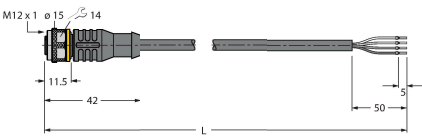
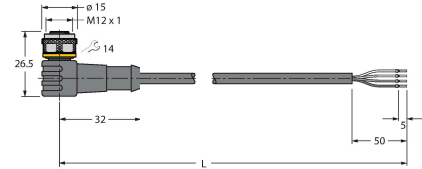
Dimension drawing	Type	ID	
	RKC4.4T-2/TEL	6625013	Connection cable, female M12, straight, 4-pin, cable length: 2 m, sheath material: PVC, black; cULus approval; other cable lengths and qualities available, see www.turck.com
	WKC4.4T-2/TEL	6625025	Connection cable, female M12, angled, 4-pin, cable length: 2 m, sheath material: PVC, black; cULus approval; other cable lengths and qualities available, see www.turck.com