

TB-EM18WD-H1147-EX

HF Read/Write Device – For Explosion Hazardous Areas

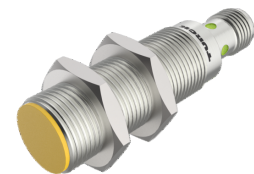
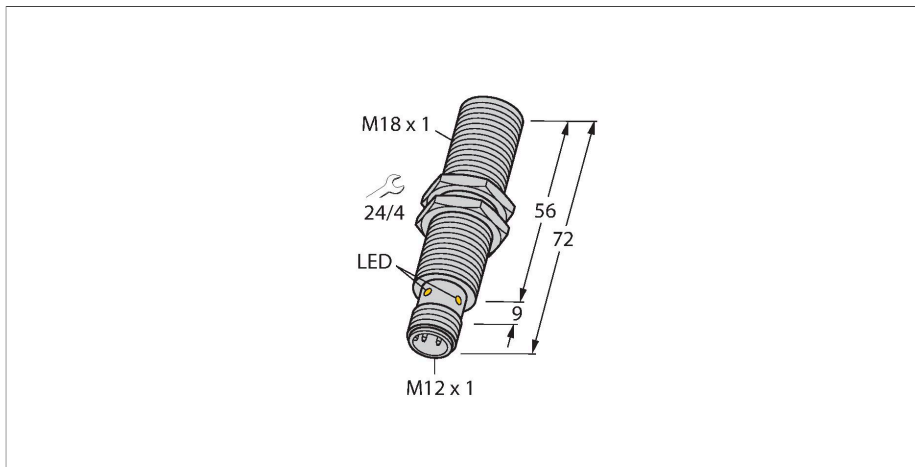

Technical data

Type	TB-EM18WD-H1147-EX
ID	7030381
Remark to product	ATEX
Approvals	CE FCC UL IC FDA ATEX
Device marking	Ⓔ II 3G Ex nA II T4 Gc II 3D Ex t IIIB T135°C Dc
Approval acc. to	TURCK Ex-10005M X
Electrical data	
Operating voltage	10...30 VDC
DC rated operational current	≤ 80 mA
inrush current	700 mA For: 1 ms
Data transfer	Inductive coupling
Technology	HF RFID
Operating frequency	13.56 MHz
Radio communication and protocol standards	ISO 15693 NFC Typ 5
Read/Write distance max.	30 mm
Output function	4-wire, Read/Write
Mechanical data	
Mounting conditions	Flush
Ambient temperature	-25...+70 °C
	For explosion hazardous areas see instruction leaflet
Design	Threaded barrel, M18 × 1
Dimensions	72 mm
Housing diameter	Ø 18 mm

Features

- Threaded barrel, M18 x 1
- Stainless steel, 1.4404
- Front cap made of liquid crystal polymer
- High protection class IP69K, for harsh environments
- Special double-lip seal
- Protection against all common acid and alkaline cleaning agents
- For the food industry
- Laser engraved label, permanently legible
- ATEX category II 3 G, Ex zone 2
- ATEX category II 3 D, Ex zone 22

.../S2503 Connectors

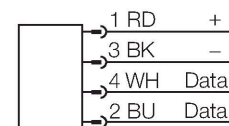

.../S2500 Connectors

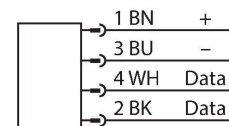

.../S2501 Connectors

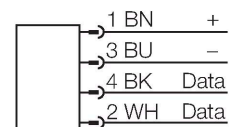

Technical data

Housing material	Stainless steel, 1.4404 (AISI 316L)
Active area material	Plastic, LCP
Vibration resistance	55 Hz (1 mm)
Shock resistance	30 g (11 ms)
Protection class	IP68 IP69K
Electrical connection	M12 × 1
MTTF	391 years acc. to SN 29500 (Ed. 99) 20 °C
Power-on indication	LED, Green
Included in delivery	SC-M12/3GD
Packaging unit	1

Functional principle

The HF read/write devices operating at a frequency of 13.56 MHz form a transmission zone, the size of which (0...500 mm) varies depending on the combination of read/write device and tag used.

The read/write distances mentioned here only represent standard values measured under laboratory conditions, free from any influences caused by surrounding materials.

The read/write distances of the tags for mounting in metal TW-R**-(MF) were determined in metal.

Attainable distances may vary by up to 30 % due to component tolerances, mounting conditions, ambient conditions and material qualities (especially when mounted in metal).

Testing of the application under real operating conditions is therefore essential, especially with on-the-fly reading and writing!

Mounting instructions/Description

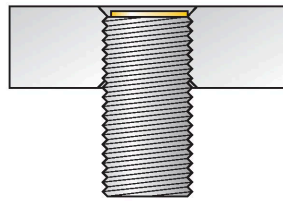

Diameter active area B	Ø 18 mm
------------------------	---------

Width active area B	18 mm
---------------------	-------

flush mounting

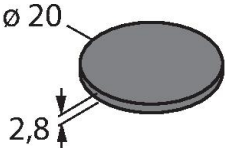
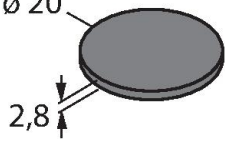
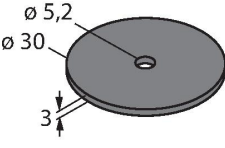
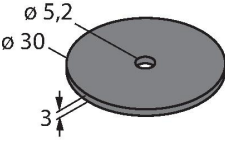
Dimensions	Type designation	Read-write distance		Transfer zone		Minimum distance between two read-write heads [mm]
		Ident - no.	Recommended (mm)	max. [mm]	length max. [mm]	
	IN TAG 200 SLIX2 100037960	8	15	12	6	54
	IN TAG 200 2K FRAM 100002358	5	12	16	8	54
	IN TAG 300 SLIX2 100002356	8	17	22	11	54
	IN TAG 300 2K FRAM 100002359	6	14	18	9	54

Accessories

MW-18

6945004

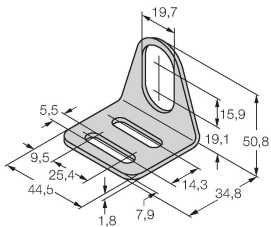

Mounting bracket for threaded barrel sensors; material: Stainless steel A2 1.4301 (AISI 304)

BSS-18

6901320

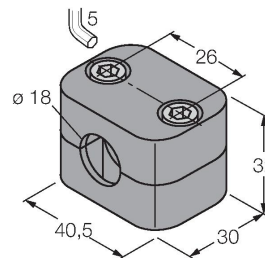

Mounting clamp for smooth and threaded barrel sensors; material: Polypropylene

PN-M18

6905310

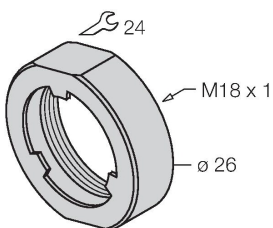

Protective nut for M18 x 1 threaded barrels; material: Stainless steel A2 1.4305 (AISI 303)