





VALVE BODY W9 TYPE P NW25

ART. NO. 850014

GENERAL

-  The KEOFITT CLASSIC W9 Sampling Valve is the original and leading sterilizable sampling valve in the world. Used in all industries for decades. More than 320 standard valve configurations. Unique serial no. for each valve*.
-  The sampling valve can be used for any process sampling for microbiological, chemical and/or physical analysis.
-  **Cleaning/sterilizing:** Between batches: Valve in open position: Cleanable by means of CIP using the detergent solution suitable for the actual process media. Between samples: Valve in its normal closed position: cleanable by CIP as "Between batches" or the valve may be sterilized by means of steam SIP or chemical SIP using a procedure appropriate to the actual circumstances. For further advice, please contact Keofitt.
-  Designed for sampling of liquids with a viscosity of up to approx. 1.000 cP containing no particles larger than Ø3 mm. Sampling of more viscous liquids is possible, only will it take longer (depending on process pressure).

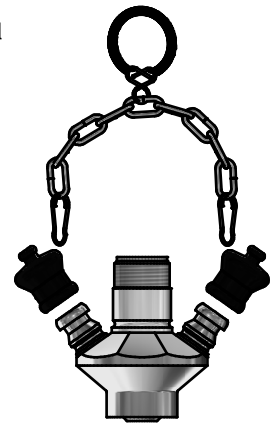

FEATURES

-  Installation: Pipe welding
-  Operation: Depending on choice of valve head
-  Inlet / Outlet: Hose piece
-  Membrane: Depending on choice of valve head

CERTIFICATION*

- EU EC 1935/2004 · EU EC 2023/2006 · DK No.822 06/2013 · 3-A Certificate · 3.1 Material Certificate · Ra Certificate
- ATEX 94/9/EC & 2014/34/EU · PED 2014/68/EU · EHEDG (2007) · Keofitt DoC

TECHNICAL DATA

Material (product contact)

- Steel parts AISI 316L (1.4404)

Material (without product contact)

- Steel parts AISI 316L (1.4404)
- Rubber cap EPDM (black)
- Stainless steel chain AISI 316L (1.4404)

Surface Treatment

- Outside Electropolished Ra ≤ 1.2 µm
- Inside (wetted surface) Electropolished Ra ≤ 0.5 µm
- Process connection Electropolished Ra ≤ 0.5 µm

Pressure & Temperature

- Pressure Depending on choice of valve head
- Temperature Depending on choice of valve head
- Air supply Depending on choice of valve head

Net Weight







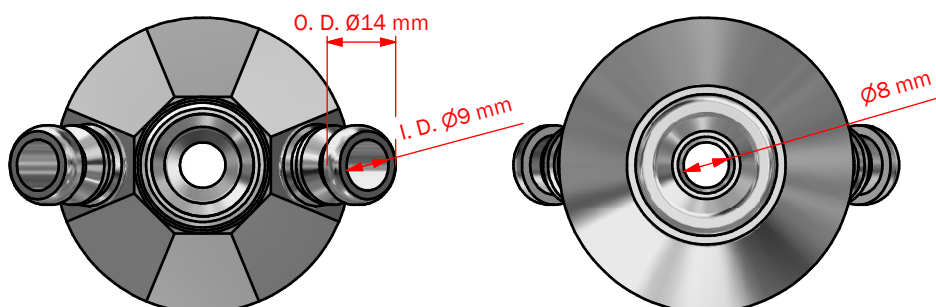
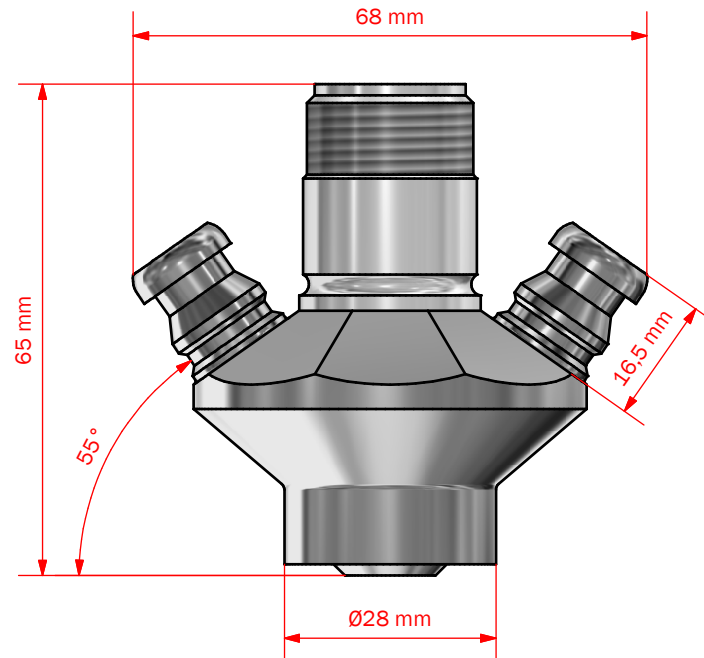

























- kg/lbs 0,308 kg / 0,67 lbs

Spareparts

- 778501 PARTS FOR W9 850001/03/11/14/21/27/28/36



KEOFITT CLASSIC W9 SAMPLING VALVE - HEADS

	Type H Turn knob	Type H Turn knob with Microport option	Type K Key ring	Type K Key ring with Microport option	Type Q Lever handle	Type N Pneumatic 0-6 bar	Type N Pneumatic, Adjustable 0-6 bar	Type B No spring 0-12 bar(£)
Silicone	 600041	 600048	 600042	 600049	 600043	 600044	 600045	 600047
EPDM	 600041E	 600048E	 600042E	 600049E	 600043E	 600044E	 600045E	 600047E
FFKM	 600041F	 Not available	 600042F	 Not available	 600043F	 600044F	 600045F	 600047F
PTFE	 855541	 Not available	 855542	 Not available	 855543	 855544	 855545	 855547